

Hydrodynamic Performance of a Moored Barge in Irregular Wave

Srinivasan Chandrasekaran, Shihash A. Khader

Abstract—Motion response of floating structures is of great concern in marine engineering. Nonlinearity is an inherent property of any floating bodies subjected to irregular waves. These floating structures are continuously subjected to environmental loadings from wave, current, wind etc. This can result in undesirable motions of the vessel which may challenge the operability. For a floating body to remain in its position, it should be able to induce a restoring force when displaced. Mooring is provided to enable this restoring force. This paper discusses the hydrodynamic performance and motion characteristics of an 8 point spread mooring system applied to a pipe laying barge operating in the West African sea. The modelling of the barge is done using a computer aided-design (CAD) software RHINOCEROS. Irregular waves are generated using a suitable wave spectrum. Both frequency domain and time domain analysis is done. Numerical simulations based on potential theory are carried out to find the responses and hydrodynamic performance of the barge in both free floating as well as moored conditions. Initially, potential flow frequency domain analysis is done to obtain the Response Amplitude Operator (RAO) which gives an idea about the structural motion in free floating state. RAOs for different wave headings are analyzed. In the following step, a time domain analysis is carried out to obtain the responses of the structure in the moored condition. In this study, wave induced motions are only taken into consideration. Wind and current loads are ruled out and shall be included in further studies. For the current study, 2000 seconds simulation is taken. The results represent wave induced motion responses, mooring line tensions and identify critical mooring lines.

Keywords—Irregular wave, moored barge, time domain analysis, numerical simulation.

I. INTRODUCTION

OFFSHORE structures are mainly used for the exploration and extraction of oil and gas from the sedimentary formations beneath the sea floor. These structures when placed in open sea, is continuously subjected to unpredictable environmental loading from wave, wind, current etc. When structural response of these floating and offshore compliant platforms largely depends on the lateral loads acting on the structure, their sensitivity to these applied loads also cause secondary vibrations [1]-[4]. This can result in undesirable motion of the platform and equipment onboard which can challenge the safe operation of these systems. In addition, the response on their exceedance beyond the permissible limits can cause operational failure or even structural damage/loss. For a floating body to be in position, it should be able to restore to the desired position when it is displaced. The areas near the coastline are the preferred site for offshore structures

for easy accessibility and economic reasons [5]. Repair and maintenance becomes easy if the structure is in close proximity with the shoreline. Shallow waters provide more challenges due to the severe non-linearity arising due to the low water depths [6].

Shallow water oil drilling dates back to as early as 1896. The first offshore oil drilling started off the coast of California. These platforms were made of narrow wooden piers that stretched up to 1350 feet from the coastline and piles were pounded using the same technique as used on land [7]. After several years of production, the wells were abandoned. Later as demand for oil and gas increased, the search for oil and gas was extended from shallow to deep and ultra-deep waters. The wells were found and drilled several miles off the shoreline.

Offshore oil production in 1950s was only about 133,000 barrels of oil per day (BOD) which increased to 1.7 million barrels of oil a day within the next 20 years. In 1990s, deep water oil production surpassed the shallow water production and a high percentage of oil and gas was produced from ultra-deep waters [8]. The oil produced offshore is taken onshore or to transportation vessels using pipelines. The pipelines are laid on the seafloor or dug below the seafloor. The pipelines bring resources to shore. The most critical and foremost part of pipeline laying is the route selection process for the pipeline. Several factors influence the path of laying. Some of them are political in nature while others are geological and environmental states including the sea bed state. Proper surveying has to be done before fixing the route for the pipeline. The other physical factors may be current induced vortices and associated vibrations, mobility of seafloor, underwater landslides due to large sedimentation rates and steep slopes, high current which may a hurdle for pipe laying operations, waves, freezing waters and floating ice may cause damage or operational failure of the pipelines and its laying operations [9].

The design of a semi-submersible wind turbine and its performance under the action of only wave loads and wind loads have been studied in [10]. An analysis shows the set down effect which is a characteristic of the shallow waters contributes to the slow drift of the moored vessel [11]. There are studies conducted which shows that wave frequency motion reduces as the water depth decreases which in turn increases the low frequency motion of the vessel [12].

Srinivasan Chandrasekaran and Shihash A. Khader are with the Department of Ocean Engineering, Indian Institute of Technology, Madras, Chennai 600036, India (e-mail: drsekaran@iitm.ac.in, shihashkader@gmail.com).

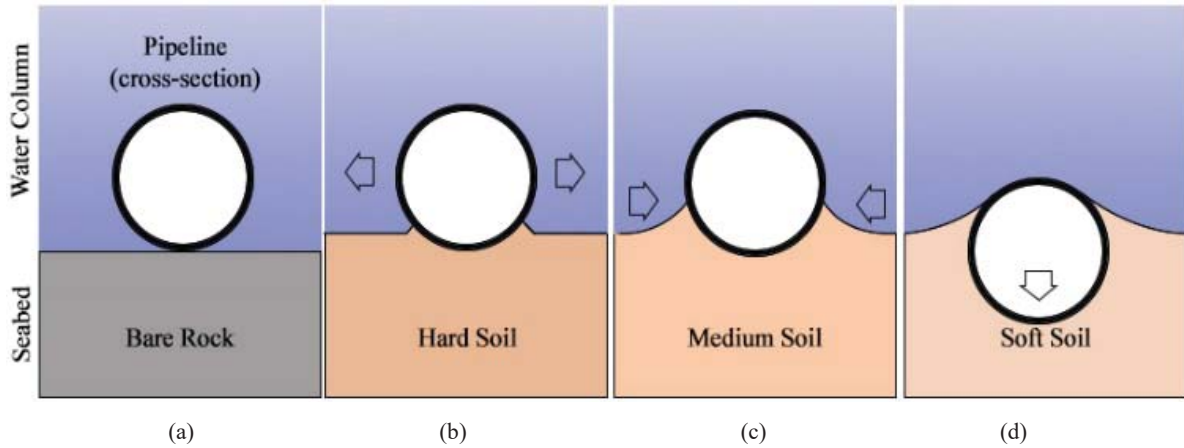

Fig. 1(a) Bare rock: Pipe subjected to abrasion or damage, (b) Hard soil: Pipe subjected to lateral migration due to current, (c) Medium soil: Better resistance to lateral migration, (d) Soft soil: Pipe sinks easily, hinders inspection and maintenance.

II. THEORY

A. Numerical Modelling

The potential theory is applied. The fluid is considered inviscid, incompressible and the flow to be irrotational. Then, the velocity potential $\varphi(x,y,z)$ can be written as [13], [14]

$$\varphi(x,y,z) = \varphi_I + \varphi_D + \varphi_R \quad (1)$$

where, φ_I is the incident velocity potential, φ_D is the diffracted velocity potential and φ_R is the radiated velocity potential. The above equation satisfies the boundary conditions and the Laplace equation. The latter is given by:

$$\nabla^2 \varphi(x,y,z,t) = 0 \quad (2)$$

B. Equation of Motion

For a barge, the general equation of motion in time domain can be written [15],

$$M\{\ddot{\xi}\} + C\{\dot{\xi}\} + K\{\xi\} = F_{static} + F_{wavefreq} + F_{slowdrift} + F_{mooring} \quad (3)$$

where, M is the mass matrix, C is the damping matrix, K is the stiffness matrix, $\{\xi\}$ is the displacement vector. Here F_{static} is the static loads due to wind and current, $F_{wavefreq}$ is the first order wave loads, $F_{slowdrift}$ is the force that is caused due to waves, wind turbulence and possibly current at frequencies which are away from the wave frequency, $F_{mooring}$ is loads from the mooring.

C. Catenary Equation

The general catenary equation may be written as [15], [16]

$$\frac{d^2 z}{dx^2} = \frac{w}{T_h} \sqrt{1 + \left(\frac{dz}{dx}\right)^2} \quad (4)$$

where, w is the submerged weight per length of the line in N/m, T_h is the horizontal component of the line tension at (x,z) .

The solution to the equation is given by

$$z = \frac{T_h}{w} \left(\cosh\left(\frac{wx}{H}\right) - 1 \right) \quad (5)$$

The bending stiffness and torsional stiffness of a mooring chain is neglected. It is important to note that the above equation does not include the influence of elasticity also.

If elastic effects are included, then the modified equations of horizontal and vertical distances are

$$dx = ds \left(1 + \frac{T}{AE} \right) \cos \varphi \quad (6)$$

$$dz = ds \left(1 + \frac{T}{AE} \right) \sin \varphi \quad (7)$$

s is the segmental line length, T is the total line tension at any point (x,z) , φ is the angle made by line to the horizontal at (x,z) .

The horizontal component of line tension is given by

$$T_h = AE \sqrt{\left(\frac{T}{AE} + 1\right)^2 - \frac{2wH}{AE}} - AE \quad (8)$$

The vertical component of the line tension is

$$V = wL \quad (9)$$

The horizontal scope of the line from fairlead to the touchdown point is

$$X = \frac{T_h}{w} \sinh^{-1} \frac{wL}{T_h} + \frac{T_h L}{AE} \quad (10)$$

III. DESCRIPTION OF THE BARGE AND MOORING LINES

A. Barge Details

The discussions made here are for a barge which is operating at shallow waters. This vessel consists of an 8 point spread mooring system to position restrain the vessel in its operational limits towards the wave attack. The barge details are given in Table I.

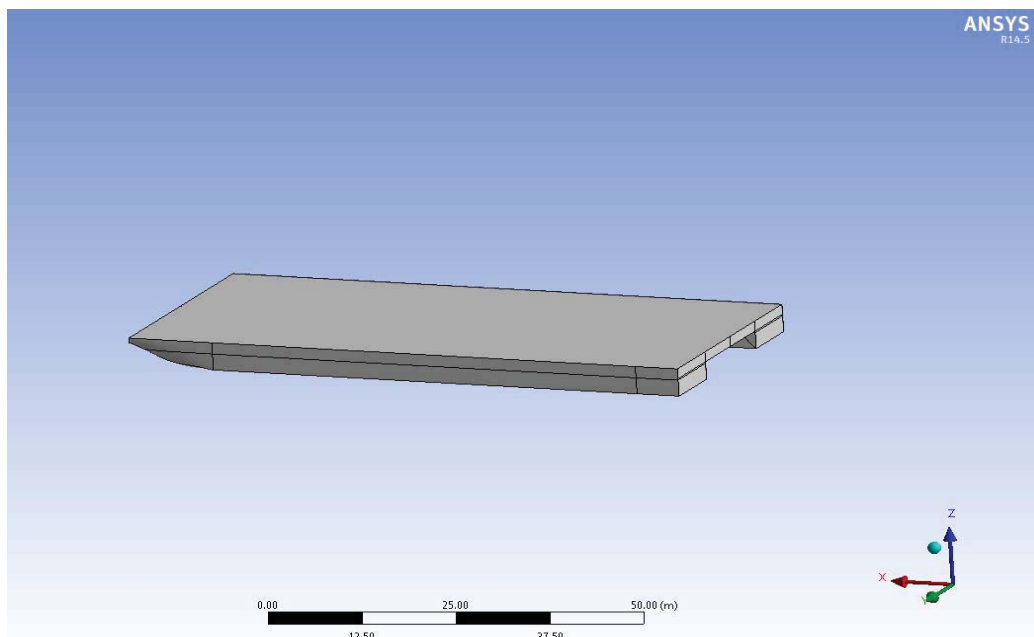

Fig. 2 Vessel model in ANSYS

TABLE I
DETAILS OF THE BARGE

Characteristics	Symbol	Unit	Value
Length	L	m	79.4
Breadth	B	m	35.35
Draft		m	2.5
Mass		ton	$6.770 \cdot 10^3$
COG		m	(38.64, 0, 4.78)
k_{xx}		m	10.1
k_{yy}		m	27.1
k_{zz}		m	25.6

TABLE II
MOORING LINE PARAMETERS

Parameters	Notation	Expression	Unit
Submerged weight per unit length	w	$0.1875D^2$	N/m
Axial stiffness per unit length	AE	$90000D^2$	N
Catalogue breaking strength	CBS	$c(44-0.08D)D^2$	N

The value of c depends on the material grade of chain using [17], [18].

B. Coordinate System

The positive x-axis is taken to be towards the bow while the positive y axis is pointing towards the port side of the vessel. The z-axis is pointed towards the sky normal to the mean sea level. The coordinate origin is taken at the mid ship on mean sea level (MSL) at the stern.

C. Mooring Line Details and Configuration

A variety of mooring line types and system are used to restrain the structure onto the position. Traditionally, single anchor chain is used. But increased application of floating structures on a variety of regimes has demanded different materials, types and systems of mooring. One such type of mooring is the spread mooring system, which is one of the most common mooring systems used in offshore industries. Different types of materials are also used depending upon the functional requirements. Some of the materials widely used in

offshore industries for mooring are steel wire ropes, chains, polyester or nylon ropes etc. Chain gives the system weight and catenary effect while wire ropes gives immense elasticity and is cost efficient. So chains are usually preferred only in shallow waters. Based on the requirement, it may even use a combination of these materials for attaining the intended purpose.

In spread mooring, the mooring lines are originated from the four corners of the vessel. These lines are guided by sheaves/pulleys (for both chain and wire) or curved guides (only for high density nylon rope) at the fairlead. The chain is handled using windlass and gypsy wheel. Drum winch may also be used for managing wire rope.

Eight mooring lines are used in a spread mooring fashion which is originating from the fairleads at the four corners of the vessel. The mooring lines are kept symmetric about XZ axis. From each corner, two lines are starting which is kept at an angle 30° to each other.

Tables III and IV show the fairlead and anchor positions for the mooring lines.

TABLE III
FAIRLEAD COORDINATES

Line	Fairlead Coordinates			Unit
	x	y	z	
S1	0	-17.675	4.267	m
S2	0	-17.675	4.267	m
S3	79.4	-17.675	4.267	m
S4	79.4	-17.675	4.267	m
P1	0	17.675	4.267	m
P2	0	17.675	4.267	m
P3	79.4	17.675	4.267	m
P4	79.4	17.675	4.267	m

D. Environmental Conditions

The study is conducted by introducing a random wave generated using JONSWAP spectrum as shown in Fig. 3. The

water depth at which the vessel is deployed is 6m. Table V show the parameters for JONSWAP spectrum.

TABLE IV
ANCHOR COORDINATES

Line	Anchor Coordinates			Unit
	x	y	z	
S1	-259.808	-167.675	-6	m
S2	-150	-277.483	-6	m
S3	229.4	-277.483	-6	m
S4	339.208	-167.675	-6	m
P1	-259.808	167.675	-6	m
P2	-150	277.483	-6	m
P3	229.4	277.483	-6	m
P4	339.208	167.675	-6	m

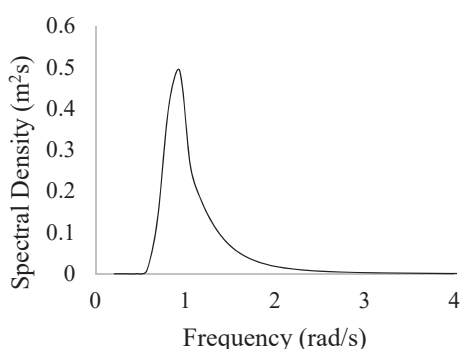

Fig. 3 JONSWAP Spectrum

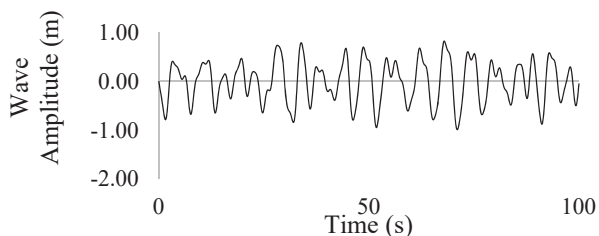

Fig. 4 Irregular wave elevation time history

Fig. 4 shows 100s time history of wave elevation for the irregular wave generated using JONSWAP spectral as mentioned in Table V.

TABLE V
JONSWAP SPECTRAL PARAMETERS

Parameters	Notation	Value	Unit
Significant wave height	Hs	1.94	m
Direction		45°	°
Gamma	γ	1.8	
Peak period	Tp	7.1	S

IV. RESULTS AND DISCUSSIONS

Numerical simulation was carried out to study the effect of variation of axial stiffness on the barge response. The hydrodynamic diffraction analysis is used for calculating the RAOs for different wave heading angles and hydrostatic properties of the vessel. In time response analysis stage, the

simulation approach used is irregular wave with slow drift in which both wave frequency motions and low period oscillatory drift motions are taken into consideration. The current effect is also taken into action. Here, the action of wind on the structure is insignificant as the structure's free board is less and it does not contain any superstructure to obstruct the wind. Further in time response analysis, the structural responses of the moored barge is calculated. The tension variation in each lines are found out.

A. Response Amplitude Operator (RAO)

The Response Amplitude Operator (RAO) or Frequency Response Function (FRF) is used to determine how the structure is going to behave when operating in a sea. This is calculated for three wave headings viz. 0°, 45° and 90° and in all six degrees of freedom.

The RAOs are found using potential theory without considering the mooring systems. The mooring system has some effect on the RAOs of low frequency motions. Apart from these effects, the non-linearity caused due to the shallow water effect also affects the RAO but the difference is tolerable.

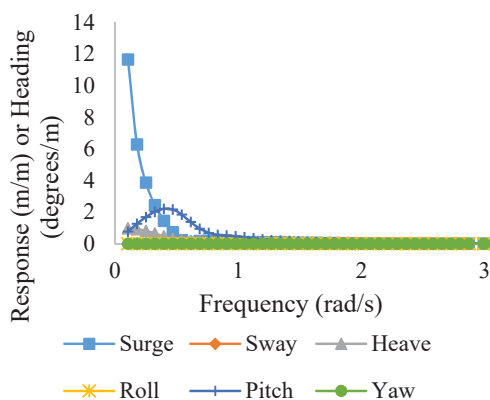

Fig. 5 Response Amplitude Operator for 0° wave heading

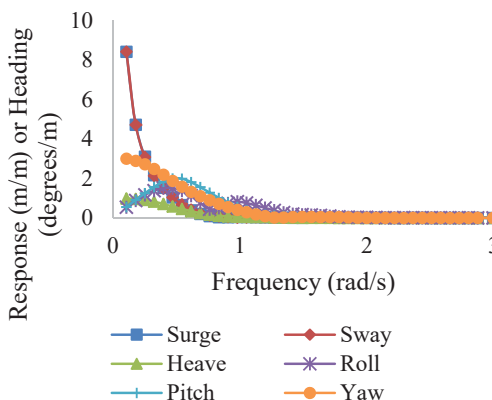

Fig. 6 Response Amplitude Operator for 45° wave heading

Surge and pitch motions are dominant in the head sea which is shown in Fig. 5. In the quarter sea, all the motions are

visible. The RAOs for 45° wave heading is described in Fig. 6. As similar to head sea, in Beam Sea, sway and roll degrees show predominant motions (shown in Fig. 7).

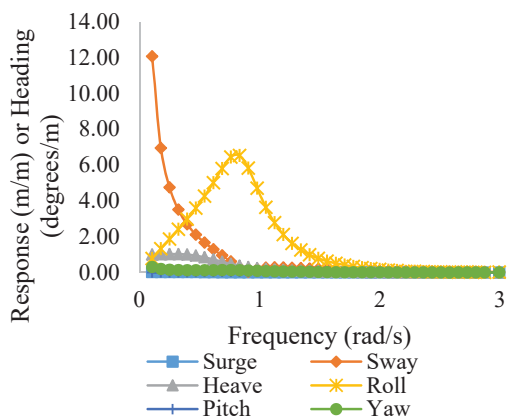

Fig. 7 Response Amplitude Operator for 90° wave heading

B. Vessel Motion

Barge motion is of great concern in random sea while in shallow waters. Barge when moored shows significant resonance in low frequency motions especially in surge and sway degrees in Quarter Sea. These motions can greatly affect the performance of the mooring lines.

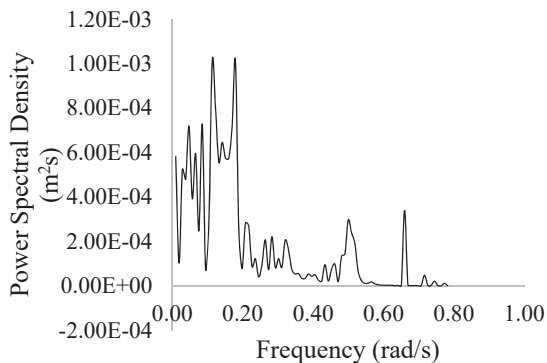

Fig. 8 Power spectral density for surge motion

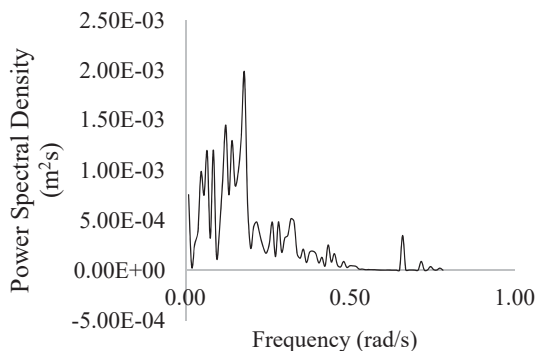

Fig. 9 Power spectral density for sway motion

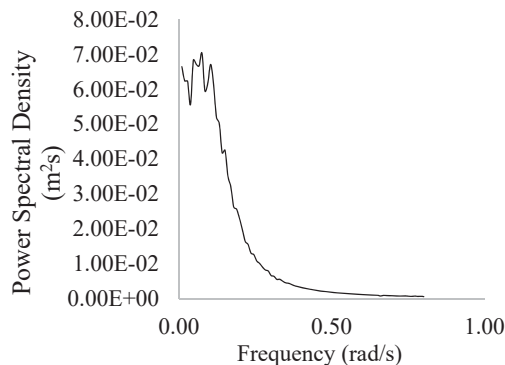

Fig. 10 Power spectral density for heave motion

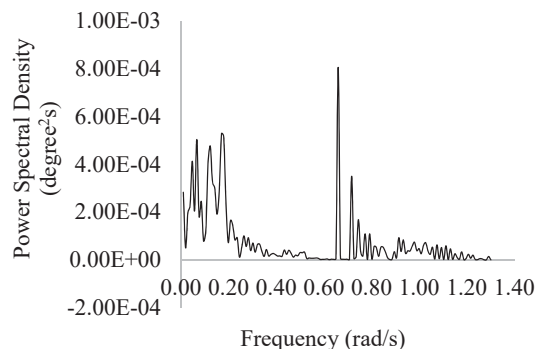

Fig. 11 Power spectral density for roll motion

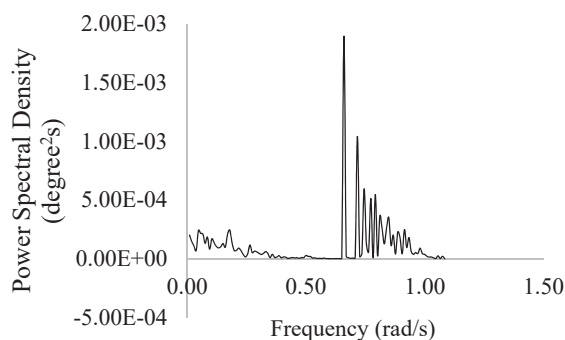

Fig. 12 Power spectral density for pitch motion

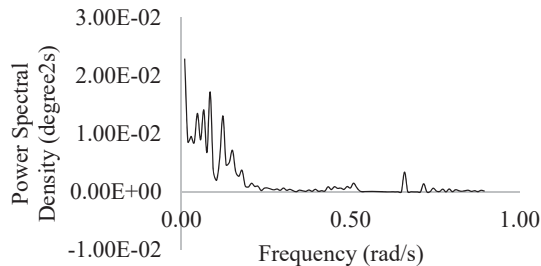

Fig. 13 Power spectral density for yaw motion

Figs. 8-13 show the power spectral density of surge, sway, heave, roll, pitch and yaw motions respectively. It is clearly seen that the surge, sway and yaw motion i.e. in the horizontal degrees, the vessel exhibits dominant low frequency motion which is seen in Figs. 8, 9 and 13. Set-down effect becomes

evident as water becomes shallower, which results in the increase in first order wave force acting on the structure. This will significantly increase the horizontal degree motions.

The roll and pitch motions are not as much affected by mooring as surge, sway and yaw motion. These degrees have higher frequency motions as shown in Figs. 11 and 12. Heave motion have lower frequency and towards the higher frequency, the motion gets damped. This may be due to the viscous damping provided by the water column. This is evidently visible in Fig. 10.

C. Line Tension

The catenary mooring system provides compliance in different degrees of freedom which helps in reducing the large tension in mooring lines. Vessel motion and action of mooring lines are coupled dynamically. In catenary mooring system, the vertical degrees viz. heave, roll and pitch are not considerably affected by mooring. But in the horizontal degrees of freedom, viz. surge, sway and yaw motions are in general, affected significantly.

Figs. 14-21 shows the time series of variation of line tension in all the eight mooring lines, all of which having the same initial tension at the fairlead. It is clearly visible from the graphs shown in Figs. 14-21 that the some lines shows greater variation in the line tensions compared to the other lines. This is due to the orientation of mooring lines in accordance with the wave heading. According to this observation, mooring line 2 is having the most variation in tension which makes this one of the critical lines. The tension in line 2 is shooting up to 500kN while all others are below 500kN.

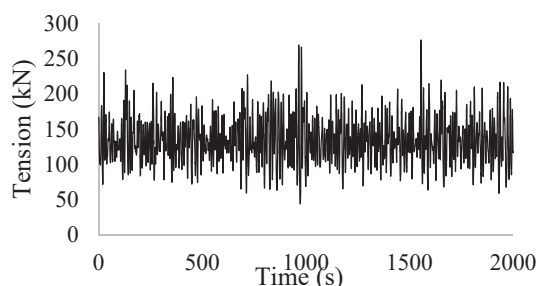

Fig. 14 Time series of mooring line 1

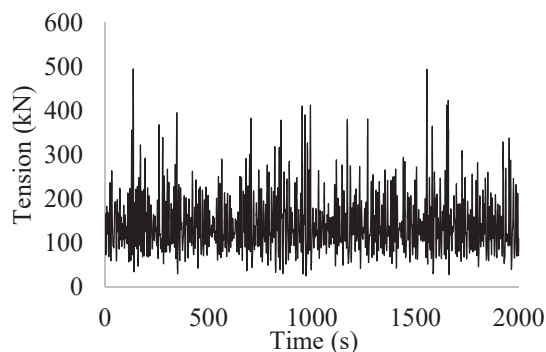

Fig. 15 Time series of mooring line 2

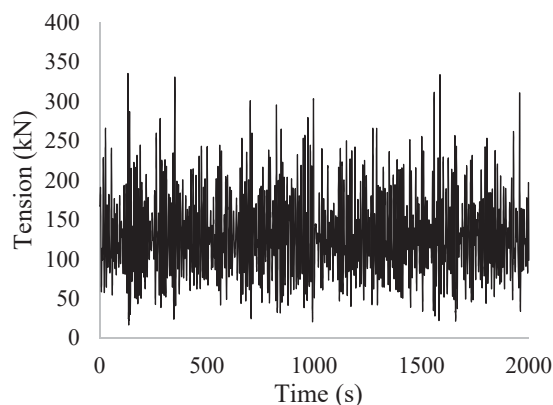

Fig. 16 Time series of mooring line 3

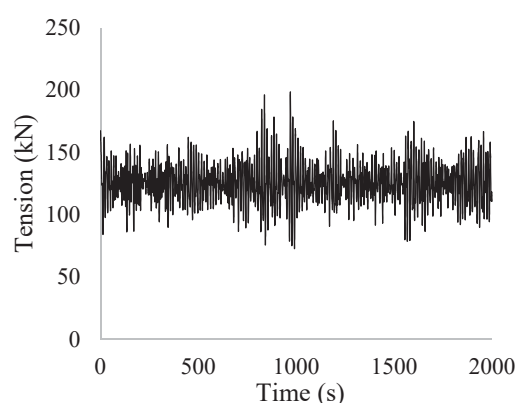

Fig. 17 Time series of mooring line 4

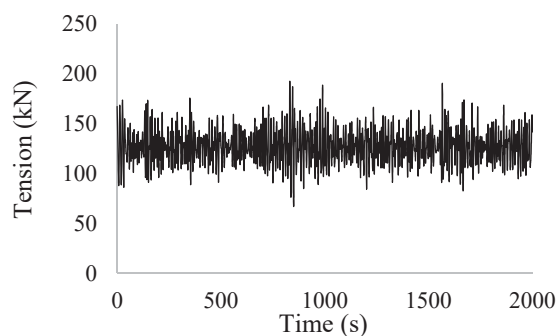

Fig. 18 Time series of mooring line 5

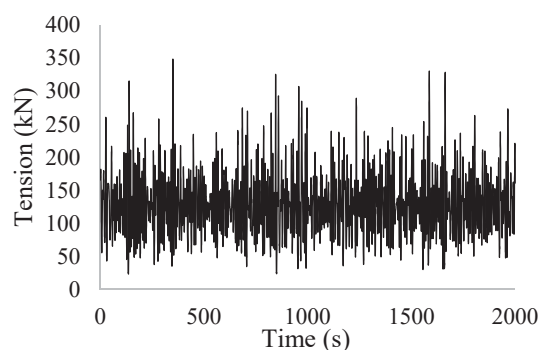

Fig. 19 Time series of mooring line 6

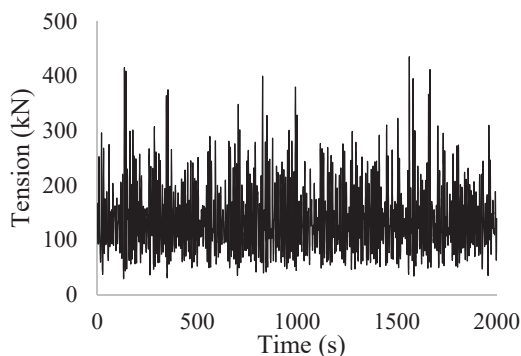

Fig. 20 Time series of mooring line 7

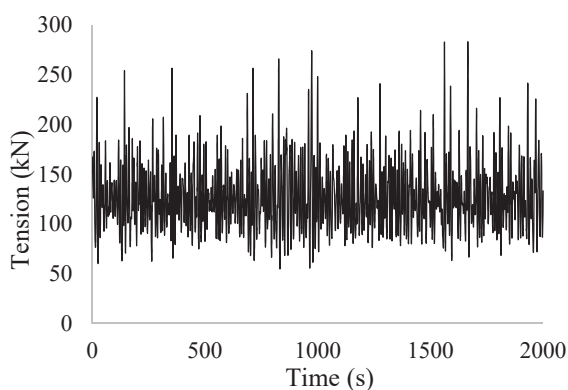

Fig. 21 Time series of mooring line 8

Statistical characteristics of the mooring line tension have been presented in Fig. 22 for the examined environmental condition. The chart gives the mean, standard deviation, minimum and maximum values for the 2000s sample for all the eight mooring lines. Due to symmetric arrangement of the mooring lines around the vessel, two lines (e.g. ML 1 and ML 8) show similar statistical characteristics. It is clear that ML 2 and ML 7 shows the maximum tension and standard deviation, followed by ML 3 and ML 6. As these values are comparably less compared to the breaking strength of the mooring line material which is above 1200kN, the system works fine in the given environmental condition.

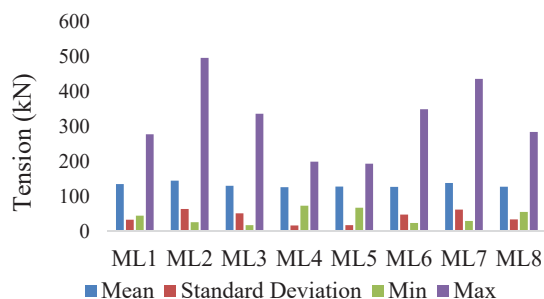

Fig. 22 Statistical characteristics of the mooring lines tension for stochastic wave induced environmental condition

V. CONCLUSION

This paper presents the dynamic response of a moored

barge and the behavior of the mooring lines for the given environment. The structure is modelled using a CAD software RHINOCEROS and the model is imported to ANSYS Aqwa 14.5. The RAOs for 6 DOF is obtained for non-moored condition using potential flow frequency domain diffraction analysis. Further, a time domain analysis is carried out for 2000s to find out the behavior of the structure in moored condition. From these two analysis, the behavior of the vessel without and with mooring is studied. The horizontal degrees of motion show dominant low frequency motions while in the vertical degrees, greater value of high frequency motions are predominantly visible. The studies show that the mooring lines perform safe in the given wave environment. The maximum tension generated in the mooring line is well below its nominal breaking strength.

In general, this paper gives an overview on the performance of the moored barge in a generated wave environment using a wave spectrum. The present results give an idea on the magnitude of the structural response and mooring line tension variation. More studies must be performed on a long term analysis basis in order to predict the responses more precisely and accurately.

REFERENCES

- [1] Chandrasekaran, S., Bhattacharyya, S.K., "Analysis and Design of Offshore Structures with illustrated examples", Human Resource Development Center for Offshore and Plant Engineering (HOPE Center), Changwon National University Press, Republic of Korea, 2012, ISBN: 978-89-963915-5-5, pp. 285.
- [2] Chandrasekaran, S., "Advanced Theory on Offshore Plant FEED Engineering", Changwon National University Press, Republic of South Korea, 2014, ISBN: 978-89-969792-8-9, pp. 237.
- [3] Chandrasekaran, S., "Dynamic analysis and design of ocean structures", Springer, 2015(a), ISBN: 978-81-322-2276-7.
- [4] Chandrasekaran, S., "Advanced Marine Structures", CRC Press, 2015(b), ISBN: 9781498739689.
- [5] Kim, Y.S., Sun, H.G., Kim, J.H., et al., "An experimental study on the response of FSRU in shallow water in comparison of mooring systems.", in The 22nd International Offshore and Polar Engineering Conference, Rhodes, Greece, 2012, pp. 875-880.
- [6] Xiao, L., Tao, L., Yang, J., Li, X., "An experimental investigation on wave run-up along the broadside of a single point moored FPSO exposed to oblique waves", Ocean Engineering 88 (0), 2014, pp. 81-90.
- [7] BP Deep Horizon Oil Spill Commission, "A Brief History of Offshore Oil Drilling", National Commission on the BP Deepwater Horizon Oil Spill and Offshore Drilling, 2010.
- [8] Whitaker, J., "Striking a Balance: Environment and Natural Resources Policy in the Nixon-Ford Years", American Enterprise Institute/Hoover Institution Policy Studies, 1976, pp. 260.
- [9] Palmer, A.C., King, R.A., "Subsea Pipeline Engineering", 2nd edition, PennWell Corp., ISBN: 1593701330, 2008, pp. 624.
- [10] Karimirad, M., Michalides, C., "V-shaped semisubmersible offshore wind turbine: An alternative concept for offshore wind technology", Renewable Energy (83), 2015, pp. 126-143.
- [11] Molin, B., Fauveau, V., "Effect of wave-directionality on second order loads induced by the set-down", Applied Ocean Research, 1984, 6 (2), pp. 66-72.
- [12] Li, X., Yang, J., Xiao, L., "Motion analysis on a large FPSO in shallow water", in Proceedings of the 13th International Offshore and Polar Engineering Conference, 2003, pp. 235-239.
- [13] Zhao, W., Yang, J., Hu, Z., Tao, L., "Prediction of hydrodynamic performance of an FLNG system in side-by-side offloading operations", Journal of Fluid Structure (46), 2014, pp. 89-110.
- [14] Faltinsen, O.M., "Sea Loads on Ships and Offshore Structures", Cambridge University Press, ISBN: 0521458706, 1990.
- [15] Barltrop, N.D.P., "Floating Structures: a guide for design and analysis", Vol. 2, CMPT and OPL, 1998.

- [16] Xiong, L., Lu, H., Yang, J., Zhao, W., "*Motion responses of a moored barge in shallow water*", *Ocean Engineering* (97), 2015, pp. 207-217.
- [17] API. RP-2SK, "*Design and analysis of station keeping systems for floating structures*", American Petroleum Institute, 3rd Edition, Oct. 2005.
- [18] DNV Offshore Standard DNV-OS-E301, "*Position Mooring*", Det Norske Veritas, Oct. 2013.