

# Mathematical Modeling of Human Cardiovascular System: A Lumped Parameter Approach and Simulation

Ketan Naik, P. H. Bhathawala

**Abstract**—The purpose of this work is to develop a mathematical model of Human Cardiovascular System using lumped parameter method. The model is divided in three parts: Systemic Circulation, Pulmonary Circulation and the Heart. The established mathematical model has been simulated by MATLAB software. The innovation of this study is in describing the system based on the vessel diameters and simulating mathematical equations with active electrical elements. Terminology of human physical body and required physical data like vessel's radius, thickness etc., which are required to calculate circuit parameters like resistance, inductance and capacitance, are proceeds from well-known medical books. The developed model is useful to understand the anatomic of human cardiovascular system and related syndromes. The model is deal with vessel's pressure and blood flow at certain time.

**Keywords**—Cardiovascular system, lumped parameter method, mathematical modeling, simulation.

## NOMENCLATURE

$\mu$	- Fluid Viscosity
R	- Resistivity of Blood Vessel (Resistance)
C	- Compliance of Blood Vessel (Capacitor)
T	- Duration of Cardiac Cycle
V	- Volume of Blood in Vessel
$T_{as}$	- Time of Atrial contraction
$T_{av}$	- Time between the one set of atrial and Ventricle systole
la	- Left Atrium
ra	- Right Atrium
$B_{mv}$	- Resistance in Mitral Valve
$B_{av}$	- Resistance in Aortic Valve
$E_{ch}(t)$	- Elastance function for Heart Chamber
$e_{ch}(t)$	- Normalized Time varying function
$a_{chD}$	- Minimum diastolic elastance of Chamber
PT	- Pulmonary Trunk
Rcap	- Right Capillary
RPA	- Right Pulmonary Artery
Rpvenous	- Right Pulmonary Venous
E	- Young's Modulus of Elasticity
h	- Wall Thickness of Blood Vessel
L	- Blood Inertance (Inductor)
Q	- Flow in Blood Vessel
P	- Pressure in Blood Vessel
$t_c$	- Elapsed time during each cardiac cycle

Ketan Naik is with Department of Applied Sciences, Parul University, Vadodara, Gujarat - 391760, India (phone: 912652635143; e-mail: ketan.naik@paruluniversity.ac.in).

P.H. Bhathawala was with Veer Narmad South Gujarat University, Surat, Gujarat - 39007 India. He is now retired from the University (e-mail: pcb101@yahoo.com).

$T_{vs}$	- Time of Ventricles contraction
lv	- Left Ventricle
rv	- Right Ventricle
$B_{pv}$	- Resistance in Pulmonary Valve
$B_{tv}$	- Resistance in Tricuspid Valve
$V_{d,ch}$	- Death Blood Volume of Heart Chamber
$a_{chs}$	- Maximum systolic elastance of Chamber
Sv	- Vena Cava Vein (Superior and Inferior)
Pv	- Pulmonary Vein
Rart	- Right Artery
LPA	- Left Pulmonary Artery
$V_{un}$	- Unstressed Volume
Lpvenous	- Left Pulmonary Venous

## I. INTRODUCTION

THIS work is about the mathematical modeling of cardiovascular system using Lumped parameter model and simulation of these models using MATLAB software.

The cardiovascular system, base of our study, is fully analogous to the electrical circuits. In fact, for every closed fluid system, there is an electrical circuit whose behavior is alike (up to conversion factors). Rideout et al. [15]-[19] used a lumped parameter model approach in learning of various parts of cardiovascular systems in their study. While emerging a model of the human systemic arterial tree, Snyder et al. [20] used an equal volume modeling feature in the simulation. According to the equal volume feature, the arterial system has been separated into segments in which length and cross sectional area was in reverse proportional [20].

Commonly, models created on lumped representations were employed to accomplish this job [8], Liang and Liu [22]; Formaggia, et al. [9]; incorporating 0D models to simulate flow in the larger arteries, veins and cardiac circulation. Avolio had created multi-branch model of the human arterial system based on the functional branching structure of arterial tree [2]. Olfusen et al. developed a lumped parameter model for systemic arteries of human cardiovascular system using the fluid dynamic equations [6], [13]. The model for arterial system with 42 section was derived by Hassani et al. [1], [4].

## II. METHOD

Arteries and veins may be assumed to be made up of cylindrical vessels with linearly elastic walls, and for a good approximation, the blood flows in arteries and veins may be regarded as an incompressible fluid with simple Newtonian characteristics [5]. Let us initially assume that vessel walls are

rigid, the input and output pressures are  $P_i$  and  $P_o$  and the flow is  $f$ . Let the internal radius of vessel be  $r$ , with corresponding cross-sectional area  $A = \pi r^2$ . Also let vessel length be  $\Delta z = l$ . The force moving the blood in the segment is given by the product of the pressure difference between its ends and the area.

$$(P_i - P_o) * A$$

Here we assume that the pressure is uniform across the diameter of the vessel. This force is balanced by fluid flow resistance and of fluid mass acceleration. The resistance to flow is approximated by Poiseuille steady-state formula [5].

$$R = (8 * \pi * \mu * \Delta z) / A^2 = (8 * \mu * \Delta z) / \pi * r^4 \quad (1)$$

where  $\mu$  is fluid viscosity. If it can be assumed that the flow is uniform across the diameter of the vessel, the viscous resistance part of the pressure drop is given by

$$(P_i - P_o)_{vis} = f * R \quad (2)$$

To find the pressure drop due to acceleration of the mass of the blood in segment, we determine the mass as

$$M = \rho * A * \Delta z \quad (3)$$

where  $\rho$  is blood density. If we assume that the blood flow is of uniform velocity  $v$  across the vessel radius, then the total flow is  $f = v * A$ . The force needed to balance acceleration of blood in the vessel will be, given by Newton's Second law:

$$M \frac{dv}{dt} = (\rho * A * \Delta z) * \frac{d(f/A)}{dt} = (\rho * \Delta z) * \frac{df}{dt} \quad (4)$$

This acceleration force must equal the acceleration part of the pressure difference between the ends of the vessel times its cross-sectional area,  $(P_i - P_o) * A$ . Using this on the left side of (4) and dividing through by  $A$ , we get the acceleration part of the pressure drop:

$$(P_i - P_o)_{accel} = (\rho * \Delta z / A) * \frac{df}{dt} \quad (5)$$

The coefficient of the flow derivative in this equation is called inductance  $L$  (Inductance in electrical circuit) [5]

$$L = (\rho * \Delta z / A) \quad (6)$$

The sum of the viscous resistance and mass acceleration pressure drops given by (2) and (5) gives the total pressure drop

$$(P_i - P_o) = (R * f) + (L * \frac{df}{dt}) \quad (7)$$

where  $L$  and  $R$  are given by (1) and (6).

A correction for the fact that the velocity is low near the walls of the vessel, with an overall parabolic cross section of

flow velocities (in steady state), gives a slightly better value for the inductance  $L$  based on a two radial segment approximation [20]

$$L = \frac{9 * \rho * \Delta z}{4 * A} = \frac{9 * \rho * \Delta z}{4 * \pi r^2} \quad (8)$$

So far, we have neglected the elasticity of the vessel walls. It can be shown that the compliance  $C$  of the cylindrical vessel of radius  $r$ , length  $\Delta z$ , wall thickness  $h$  and Young's bulk modulus of elasticity  $E$ :

$$C = \frac{3 * \pi * r^3 * \Delta z}{2 * E * h} \quad (9)$$

### III. MATHEMATICAL MODELING

In this section, we represent modified and extended models for pulmonary circulation and systemic circulation. Modeling explanations are mainly followed from [6], [3] and [1]. Fig. 1 shows hemodynamics of cardiovascular system.

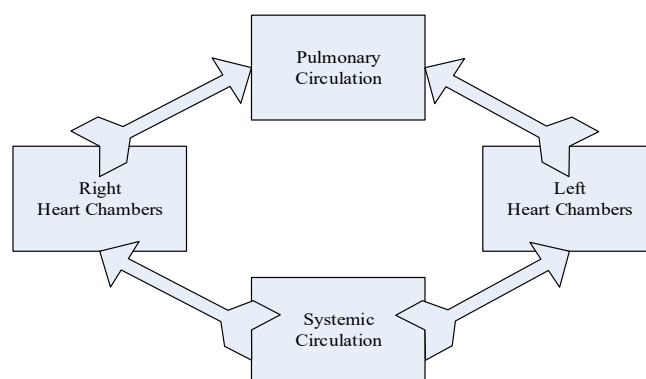

Fig. 1 Hemodynamics of Cardiovascular System

#### Assumptions for the Models

- I. The blood flows in parallel layers with no disruption of layers i.e. laminar flow.
- II. The model is not dealing with any kind of control mechanism like baroreceptors and central nervous systems.
- III. Body tissues have not any membrane association, means there is no dispersion throughout membrane.
- IV. Blood vessels are cylindrical and walls of vessels are flexible.
- V. Vessel's curve is ignored (there is no turbulence flow).
- VI. The unidirectional blood flow is represented by diode.
- VII. All the blood vessels have not any physiological bifurcation. Although, the model contains loops presenting blood vessels from various part of human body.
- VIII. Effect of gravitational force on human body is not considered.

#### A. Mathematical Modeling of Heart

We have divided heart in four chambers: a) Left Atrium, b) Left Ventricle, c) Right Atrium, d) Right Ventricle.

Pressure-Flow in Left Atrium

From Fig. 2 we have

$$\frac{dQ_{la}}{dt} = \frac{1}{L_{la}}(P_{la} - P_{lv}) - \frac{R_{la}Q_{la}}{L_{la}} - \frac{Sgn(Q_{la})B_{mv}Q_{la}}{L_{la}} \quad (10)$$

When  $P_{la} - P_{lv} > 0$ , then valve is open, and  $Q_{la} > 0$ , which implies  $(Q_{la}) = 1$ . If  $P_{la} - P_{lv} < 0$ , then  $Q_{la} = 0$ . If  $P_{la} - P_{lv} = 0$  then and only then, back flow is possible. In this case  $Q_{la} < 0$  and  $Sgn(Q_{la}) = -1$ . Now let assume first  $P_{la} - P_{lv} > 0$  then equation becomes

$$\therefore \frac{dQ_{la}}{dt} = \frac{1}{L_{la}}(E_{la}(t)(V_{la} - V_{d,la}) - E_{lv}(t)(V_{lv} - V_{d,lv})) - \frac{R_{la}Q_{la}}{L_{la}} - \frac{B_{mv}Q_{la}}{L_{la}} \quad (11)$$

$$\therefore \frac{dQ_{la}}{dt} = \frac{1}{L_{la}}(a_{las}e_{la}(t) + a_{lad})(V_{la} - V_{d,la}) - (a_{lvs}e_{lv}(t) + a_{lvD})(V_{lv} - V_{d,lv}) - \frac{R_{la}Q_{la}}{L_{la}} - \frac{B_{mv}Q_{la}}{L_{la}} \quad (12)$$

also,

$$\frac{dV_{la}}{dt} = Q_{pv} - Q_{la} \quad (13)$$

where  $Q_{pv}$  is average flow in Pulmonary Veins.

$$a_{las} = 93.31 \frac{\text{dyne}}{\text{cm}^5} \quad [\text{From Table I}]$$

$$= 93.31 * 0.00075 \frac{\text{mmHg}}{\text{ml}} = 0.0699 \frac{\text{mmHg}}{\text{ml}}$$

$$V_{la} - V_{d,la} = 42 - 4 = 38 \text{ ml} \quad [20] \quad (14)$$

$$V_{lv} - V_{d,lv} = 83 - 40 = 43 \text{ ml} \quad [7] \quad (15)$$

TABLE I  
FOR CONVERSION IN MEDICAL UNIT [23]

	SI system (kg m s)	Cgs System(g semi s)	Medical Units
Area Compliance $C_A$	$1 \text{ m}^2/\text{Pa} = \text{m}^4/\text{N}$	$10^4 \text{ cm}^4/\text{dyn}$	$1.33 \times 10^6 \text{ cm}^2/\text{mmHg}$
Compliance C	$1 \text{ m}^3/\text{Pa} = 1 \text{ m}^5/\text{N}$	$10^5 \text{ cm}^5/\text{dyn}$	$1.33 \times 10^8 \text{ ml}/\text{mmHg}$
Bulk Modulus	$1 \text{ Pa} = 1 \frac{\text{N}}{\text{m}^2}$	$10 \frac{\text{dyn}}{\text{cm}^2}$	$7.5 \times 10^{-3} \text{ mmHg}$
Diameter Compliance $C_D$	$1 \frac{\text{m}}{\text{Pa}} = 1 \text{ m}^3/\text{N}$	$10^3 \text{ cm}^4/\text{dyn}$	$1.33 \times 10^4 \frac{\text{cm}}{\text{mmHg}}$
Elastance E	$1 \frac{\text{Pa}}{\text{m}^3} = 1 \frac{\text{N}}{\text{m}^5}$	$10^{-3} \frac{\text{dyn}}{\text{cm}^5}$	$7.5 \times 10^{-9} \frac{\text{mmHg}}{\text{ml}}$
Flow Q	$1 \frac{\text{m}^3}{\text{s}}$	$10^6 \frac{\text{cm}^3}{\text{s}} = 10^6 \frac{\text{ml}}{\text{s}}$	$1 \frac{\text{l}}{\text{min}} = 16.66 \frac{\text{ml}}{\text{s}}$
Frequency F	$\text{Hz} = \text{s}^{-1}$	$\text{Hz} = \text{s}^{-1}$	$\text{min}^{-1} (60 \text{bpm} = 1 \text{Hz})$
Inertance L	$1 \frac{\text{Pa} \cdot \text{s}^2}{\text{m}^3} = 1 \frac{\text{N} \cdot \text{s}^2}{\text{m}^3}$	$10^{-5} \frac{\text{dyn} \cdot \text{s}^2}{\text{cm}^5}$	$7.5 \times 10^{-9} \frac{\text{mmHg}}{\text{ml}}$
Young Modules	$1 \text{ Pa} = 1 \frac{\text{N}}{\text{m}^2}$	$10 \frac{\text{dyn}}{\text{cm}^2}$	$7.5 \times 10^{-3} \text{ mmHg}$
Pressure P	$1 \text{ Pa} = 1 \frac{\text{N}}{\text{m}^2}$	$10 \frac{\text{dyn}}{\text{cm}^2}$	$7.5 \times 10^{-3} \text{ mmHg}$
Resistance R	$1 \frac{\text{Pa} \cdot \text{s}}{\text{m}^3} = 1 \frac{\text{N} \cdot \text{s}}{\text{m}^3}$	$10^{-5} \frac{\text{dyn} \cdot \text{s}}{\text{cm}^5}$	$7.5 \times 10^{-9} \frac{\text{mmHg} \cdot \text{s}}{\text{ml}}$

Pressure-Flow in Left Ventricle

Left ventricle is the source of pulse waves in the cardiovascular system. Now let us assume first  $P_{lv} - P_{as} > 0$  and  $P_{as} = 91.6$ , which represent average pressure in ascending order. [3] From Fig. 2, for Left Ventricle we obtained equations as

$$\frac{dQ_{lv}}{dt} = \frac{1}{L_{lv}}(P_{lv} - P_{as}) - \frac{R_{lv}Q_{lv}}{L_{lv}} - \frac{Sgn(Q_{lv})B_{av}Q_{lv}}{L_{lv}} \quad (16)$$

In similar fashion, from Fig. 3, we have equations for Right Atrium and Right Ventricle.

$$\frac{dQ_{ra}}{dt} = \frac{1}{L_{ra}}(P_{ra} - P_{rv}) - \frac{R_{ra}Q_{ra}}{L_{ra}} - \frac{Sgn(Q_{ra})B_{tv}Q_{ra}}{L_{ra}} \quad (17)$$

$$\frac{dQ_{rv}}{dt} = \frac{1}{L_{rv}}(P_{rv} - P_{ap}) - \frac{R_{rv}Q_{rv}}{L_{rv}} - \frac{Sgn(Q_{rv})B_{av}Q_{rv}}{L_{rv}} \quad (18)$$

also,

$$\frac{dV_{rv}}{dt} = Q_{plt} - Q_{lv} \quad (19)$$

where  $Q_{plt}$  represents flow in pulmonary trunk.

$$a_{ras} = 79.98 \frac{\text{dyne}}{\text{cm}^5} \quad [\text{From Table I}]$$

$$= 93.31 * 0.00075 \frac{\text{mmHg}}{\text{ml}} = 0.0599 \frac{\text{mmHg}}{\text{ml}}$$

Similarly, we can convert remaining parameters in  $\frac{\text{mmHg}}{\text{ml}}$

$$V_{ra} - V_{d,ra} = 42 - 4 = 38 \text{ ml} \quad [20] \quad (20)$$

where,  $V_{ra}$  is Stress Volume of right Atrium in “ml” and  $V_{d,ra}$  is Un-stress Volume of right Atrium in “ml”

$$V_{rv} - V_{d,rv} = 93 - 40 = 53 \text{ ml} \quad [7] \quad (21)$$

Pressure in each chamber, denoted by  $P_{ch}$ , is given by

$$P_{ch} = E_{ch}(t)(V_{ch} - V_{d,ch}) \quad (22)$$

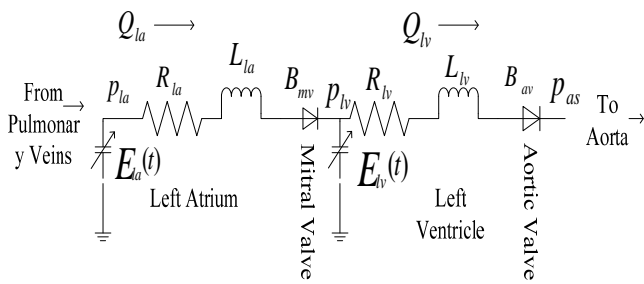

Fig. 2 Left Heart Chamber

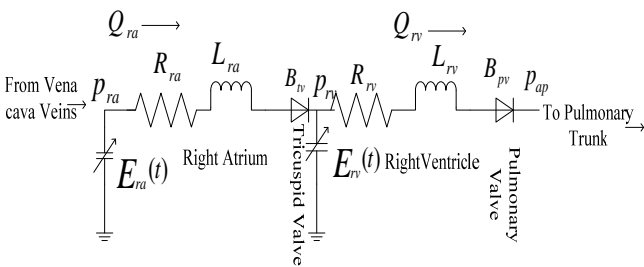

Fig. 3 Right Heart Chamber

$$E_{ch}(t) = a_{chs}e_{ch}(t) + a_{chD} \quad (23)$$

where  $a_{chs}$  is maximum Systolic Elastance of chamber,  $a_{chD}$  is minimum Diastolic Elastance of chamber.  $e_{ch}(t)$  is normalized time varying function that represents the forcing source for the model, which for atria is

$$e_{(ch),a}(t) = \begin{cases} \sin\left(\frac{\pi t_c}{T_{as}}\right) & 0 < t_c \leq T_{as} \\ 0 & T_{as} < t_c \leq T \end{cases} \quad (24)$$

and for ventricles is

$$e_{(ch),v}(t) = \begin{cases} \sin\left(\frac{\pi(t_c - T_{av})}{T_{vs}}\right) & T_{av} < t_c < T_{av} + T_{vs} \\ 0 & T_{av} + T_{vs} \leq t_c \leq T \end{cases} \quad (25)$$

Here, the subscript  $a$  denotes the atria  $v$  denotes ventricles.

### B. Mathematical Modeling of Pulmonary Circulation

In pulmonary circulation, oxygen-poor blood is circulated from right ventricle to lungs and oxygen-rich blood is circulated from lung to left atrium.

where  $V_{d,ch}$  represents the volume of chamber "ch",  $V_{ch}$  represents current chamber volume and  $E_{ch}(t)$  is Elastance function, which is given by

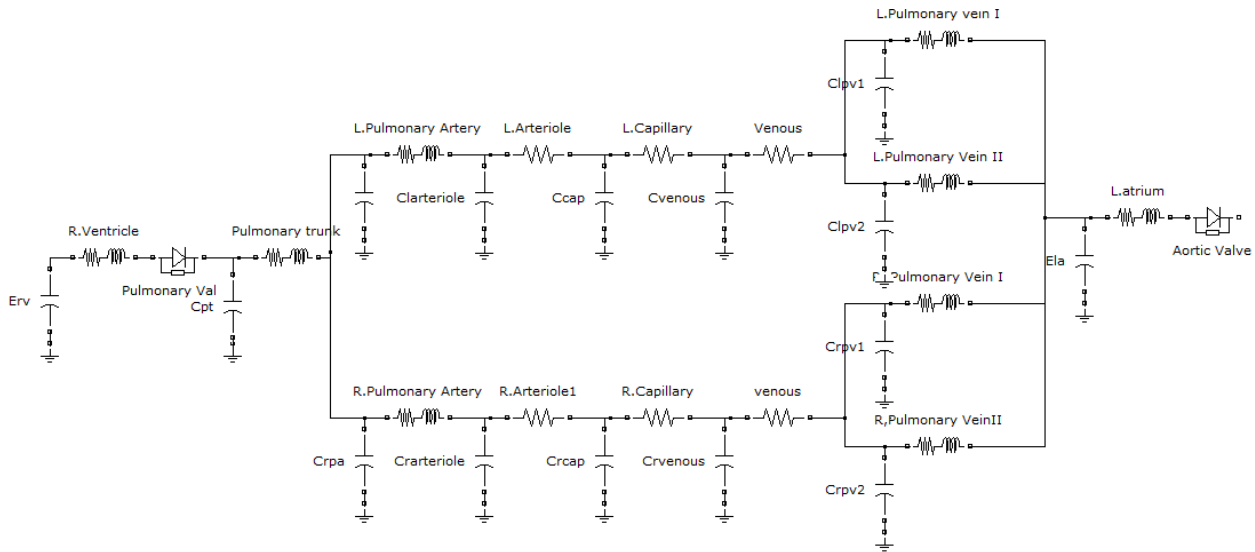

Fig. 4 Lumped Parameter Model for Pulmonary Circulation

### Pulmonary Arterial System

#### First Arterial Section

$$\frac{dQ_{PT}}{dt} = \frac{1}{L_{PT}}(p_{PA} - p_{PT}) - \frac{R_{PT}}{L_{PT}} Q_{PT} \quad (26)$$

$$\frac{dV_{PT}}{dt} = Q_{rv} - Q_{PT} \quad (27)$$

$$p_{PT} = \frac{1}{C_{PT}}(V_{PT} - V_{un,PT}) \quad (28)$$

#### Second Arterial Section

##### Left Pulmonary Artery

$$\frac{dQ_{LPA}}{dt} = \frac{1}{L_{LPA}}(p_{Lart} - p_{PA}) - \frac{R_{LPA}}{L_{LPA}} Q_{LPA} \quad (29)$$

$$\frac{dV_{LPA}}{dt} = Q_{PT} - Q_{LPA} \quad (30)$$

##### Right Pulmonary Artery

$$\frac{dQ_{RPA}}{dt} = \frac{1}{L_{RPA}}(p_{Rart} - p_{PA}) - \frac{R_{RPA}}{L_{RPA}} Q_{RPA} \quad (31)$$

$$\frac{dV_{RPA}}{dt} = Q_{PT} - Q_{RPA} \quad (32)$$

#### Arteriole Section

$$\frac{dV_{Rart}}{dt} = Q_{RPA} - Q_{Rart} \quad (33)$$

$$p_{Rcap} - p_{Rart} = R_{Rart} Q_{Rart} \quad (34)$$

Similarly for Arteriole in left lung, we have

$$\frac{dV_{Lart}}{dt} = Q_{LPA} - Q_{Lart} \quad (35)$$

$$p_{Lcap} - p_{Lart} = R_{Lart} Q_{Lart} \quad (36)$$

#### Capillary Section

$$\frac{dV_{Rcap}}{dt} = Q_{Rart} - Q_{Rcap} \quad (37)$$

$$p_{Rpv} - p_{Rcap} = R_{Rcap} Q_{Rcap} \quad (38)$$

Similarly for Capillary in left lung, we have

$$\frac{dV_{Lcap}}{dt} = Q_{Lart} - Q_{Lcap} \quad (39)$$

$$p_{Lpv} - p_{Lcap} = R_{Lcap} Q_{Lcap} \quad (40)$$

#### Pulmonary Veins System

##### First Venous Section

$$\frac{dV_{Rpv}}{dt} = Q_{cap} - Q_{Rpv} \quad (41)$$

$$p_{RPV} - p_{Rpv} = R_{Rpv} Q_{Rpv} \quad (42)$$

Similarly, we can define for venous in left lung.

##### Second Section

For all four Pulmonary veins:

$$\frac{dQ_{Pv}}{dt} = \frac{1}{L_{Pv}} (p_{Pv} - p_{la}) - \frac{R_{Pv}}{L_{Pv}} Q_{Pv} \quad (43)$$

$$\frac{dV_{Pv}}{dt} = Q_{venous} - Q_{Pv} \quad (44)$$

$$p_{Pv} = \frac{1}{C_{Pv}} (V_{Pv} - V_{un,Pv}) \quad (45)$$

#### C. Mathematical Modeling of Systemic Circulation

In systemic circulation, oxygen-rich blood is circulated from left ventricle to upper body parts and lower body part, and oxygen poor blood from different body part is circulated to right atrium.

##### Systemic Arterial System

###### First Arterial Section (Ascending Aorta)

$$\frac{dQ_{As}}{dt} = \frac{1}{L_{As}} (p_{As} - p_{AArchI}) - \frac{R_{As}}{L_{As}} Q_{As} \quad (46)$$

$$\frac{dV_{As}}{dt} = Q_{lv} - Q_{As} \quad (47)$$

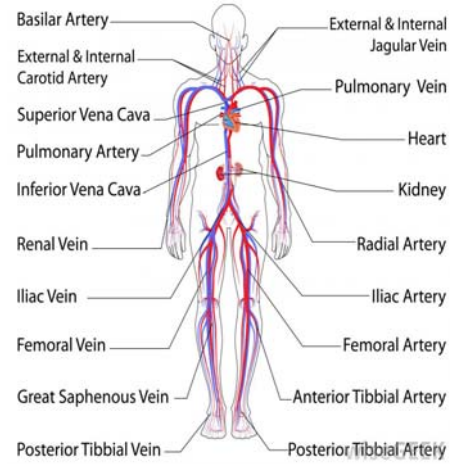

Fig. 5 Systemic Circulation

$$p_{As} = \frac{1}{C_{As}} (V_{As} - V_{un,As}) \quad (48)$$

where  $As$  represents Ascending Aorta and  $AArchI$  represents Aortic Arch I. Similarly for other systemic arteries, we can define flow, pressure relationship.

##### Systemic Capillary system (Upper and Lower Body)

$$\frac{dV_{cap}}{dt} = Q_{Arteriole} - Q_{cap} \quad (49)$$

$$p_{Svenouse} - p_{cap} = R_{cap} Q_{cap} \quad (50)$$

##### Systemic Veins (Superior Vena Cava & Inferior Vena Cava)

$$\frac{dQ_{Sv}}{dt} = \frac{1}{L_{Sv}} (p_{Sv} - p_{ra}) - \frac{R_{Sv}}{L_{Sv}} Q_{Sv} \quad (51)$$

$$\frac{dV_{Sv}}{dt} = Q_{venous} - Q_{Sv} \quad (49)$$

$$p_{Sv} = \frac{1}{C_{Sv}} (V_{Sv} - V_{un,Sv}) \quad (52)$$

where  $Sv$  represents superior and inferior vena cava vein, which is the longest vein.

#### IV. SIMULATION

The parameter values are either taken from Medical and Research literature or estimated using the formula given in previous research papers. The whole cardiovascular system model is simulated in MATLAB, Simulink using ODE45 [10]-[14]. Simulation results are compared with standard results given in medical literature. We take simulation time period as  $H$ - Heart Rate =  $60/0.8 = 75$  beats/min =  $1.25$  Hz [3] and when required, we have done unit conversation using Table I.

In our simulation model, we have taken variable compliance for left ventricle, right ventricle, left atrium and right atrium. The data for simulation are taken for a man with average 70 kg weight and in sleeping positions.



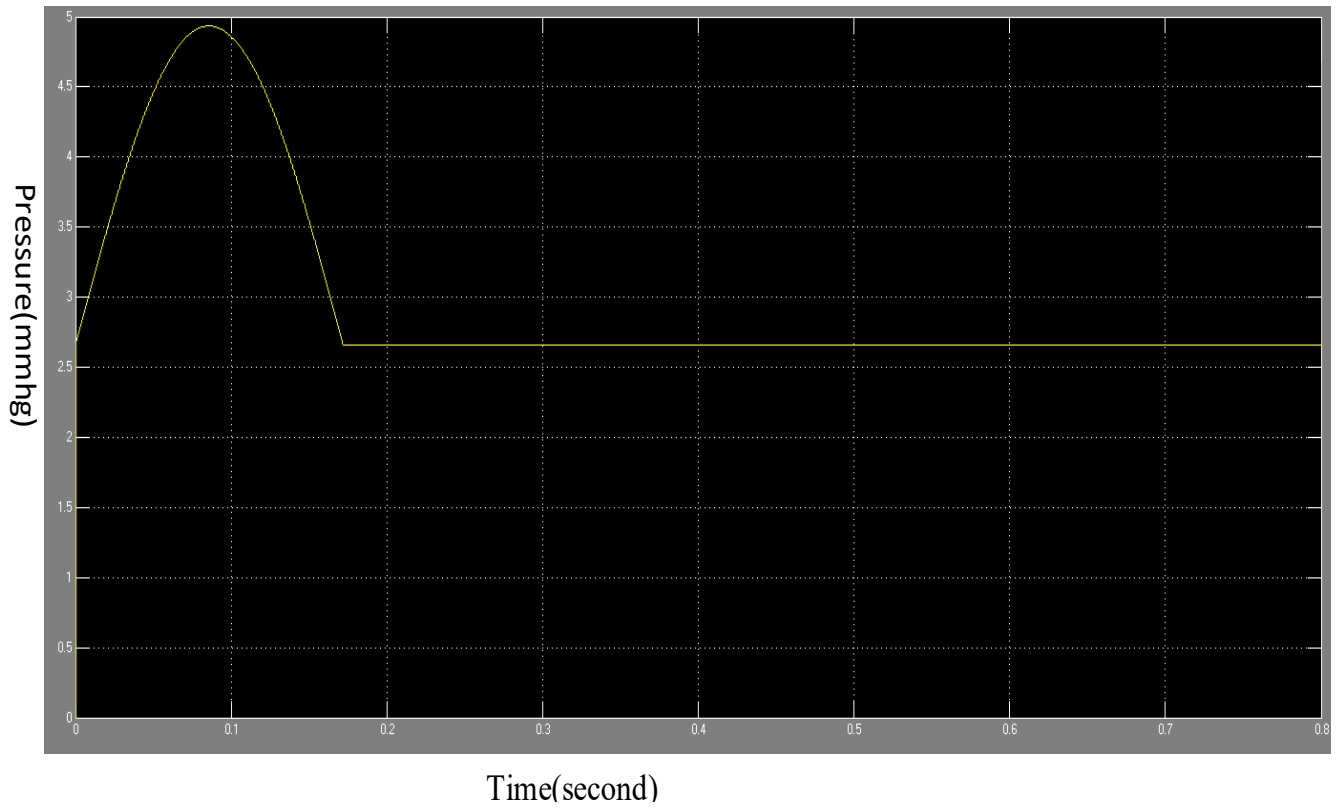

Fig. 7 Left Atrium Time vs Pressure curve

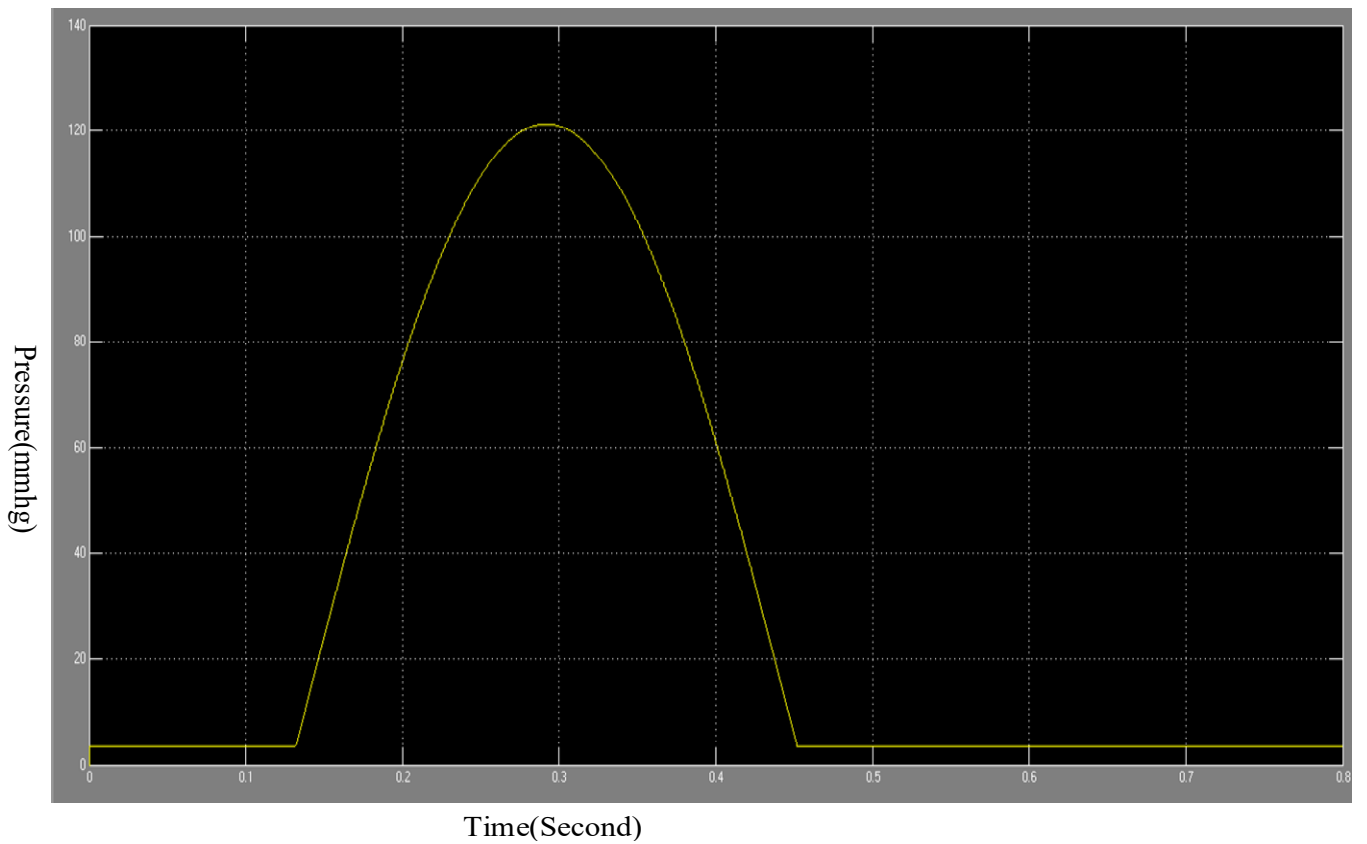

Fig. 8 Left Ventricle Time vs Pressure curve

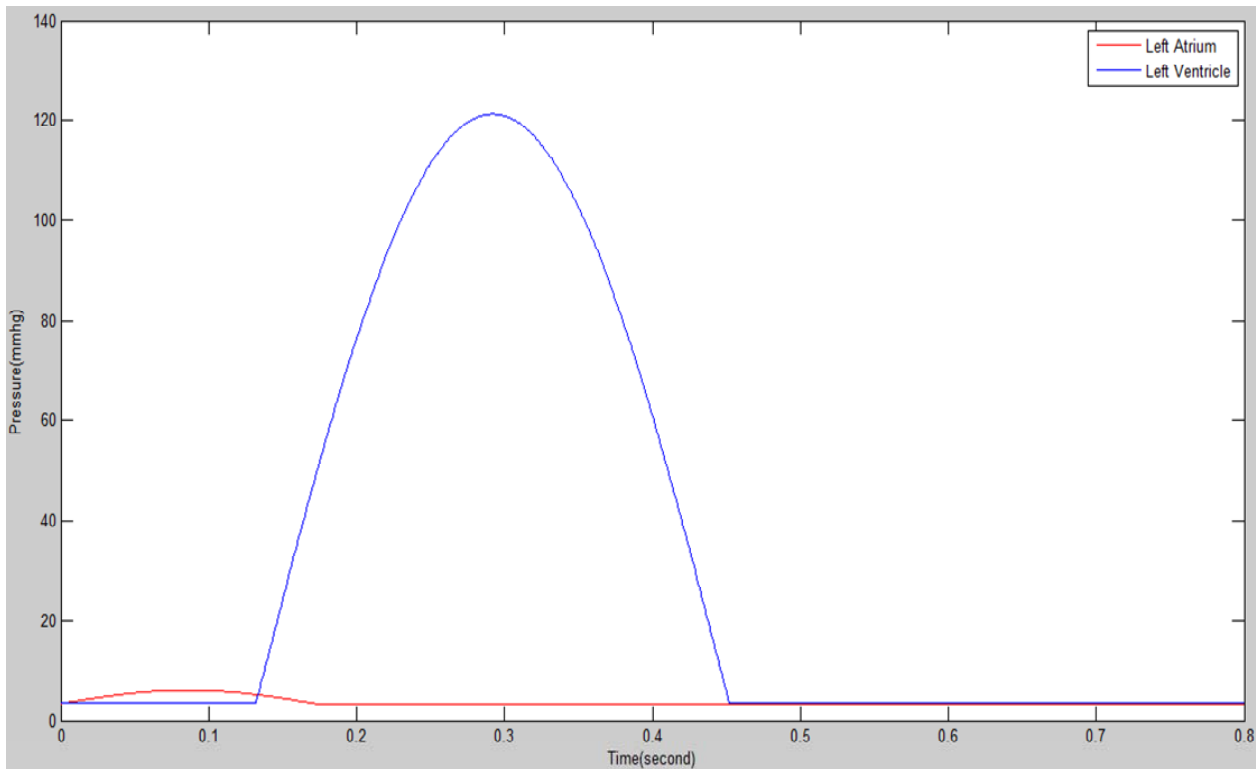

Fig. 9 Left Atrium & Left Ventricle Time vs Pressure curve

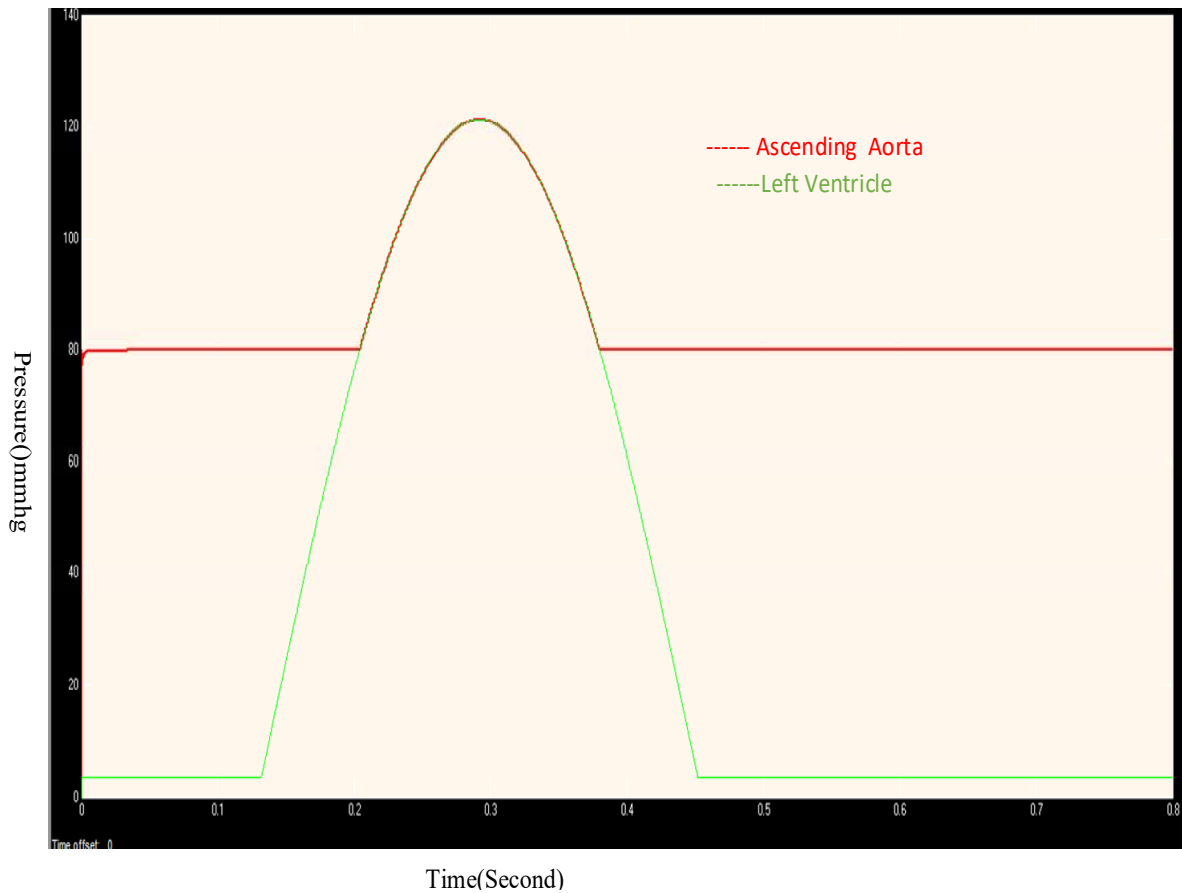

Fig. 10 Time vs Pressure Curve of Left Ventricle and Ascending Aorta



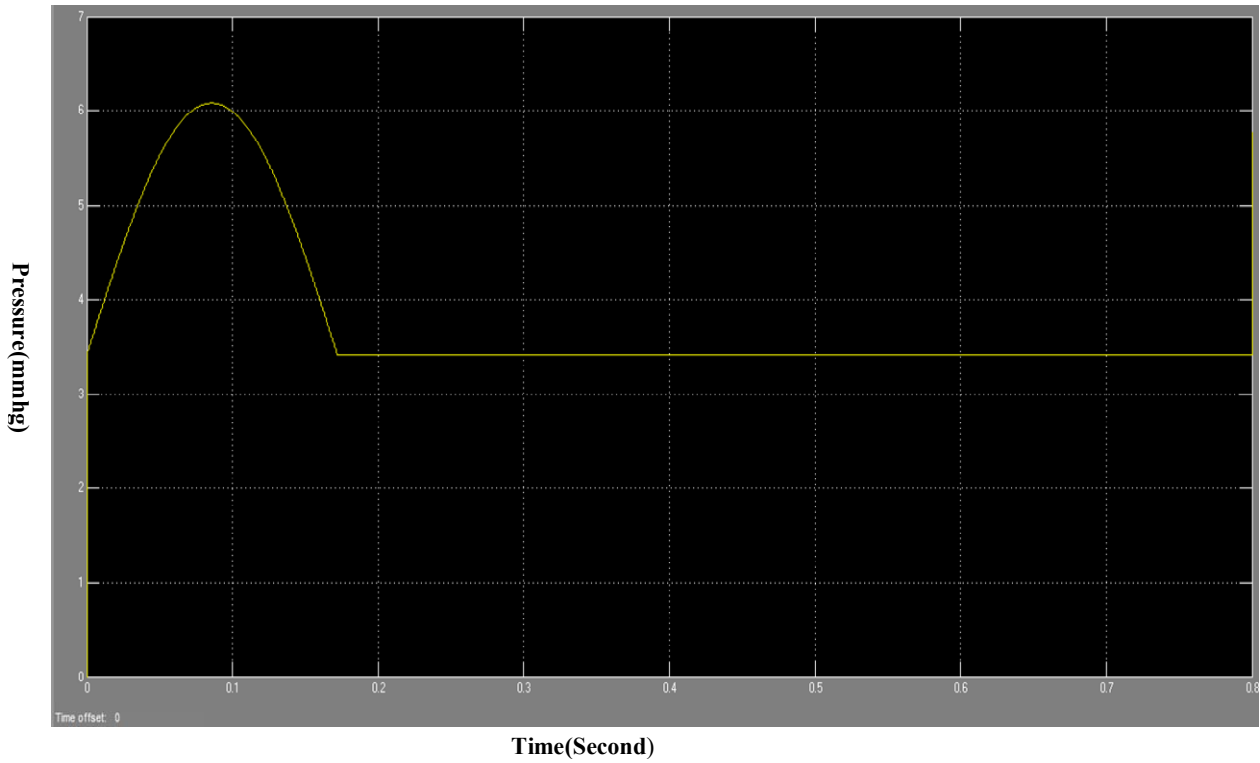

Fig. 11 Pressure vs Time curve for Right Atrium

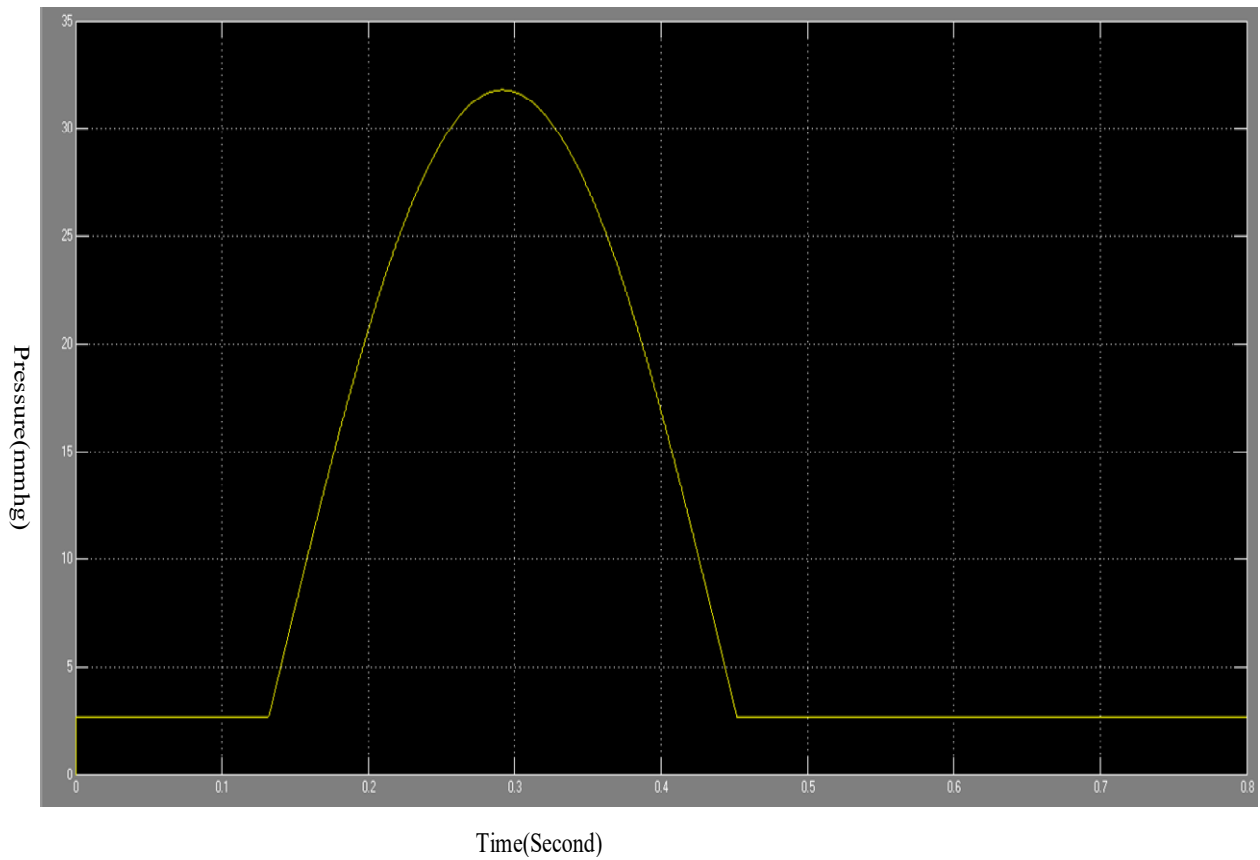

Fig. 12 Time vs Pressure Curve for Right Ventricle

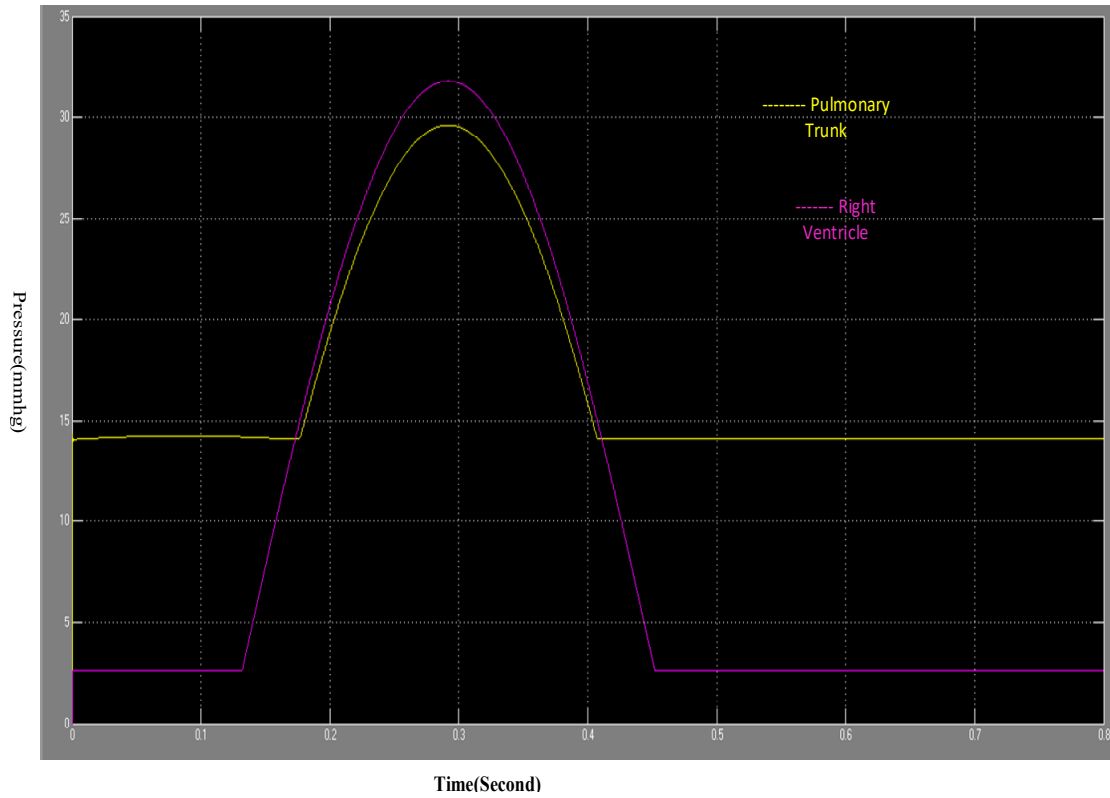

Fig. 13 Time vs Pressure Curve for Right Ventricle and Pulmonary Artery (Pulmonary Trunk)

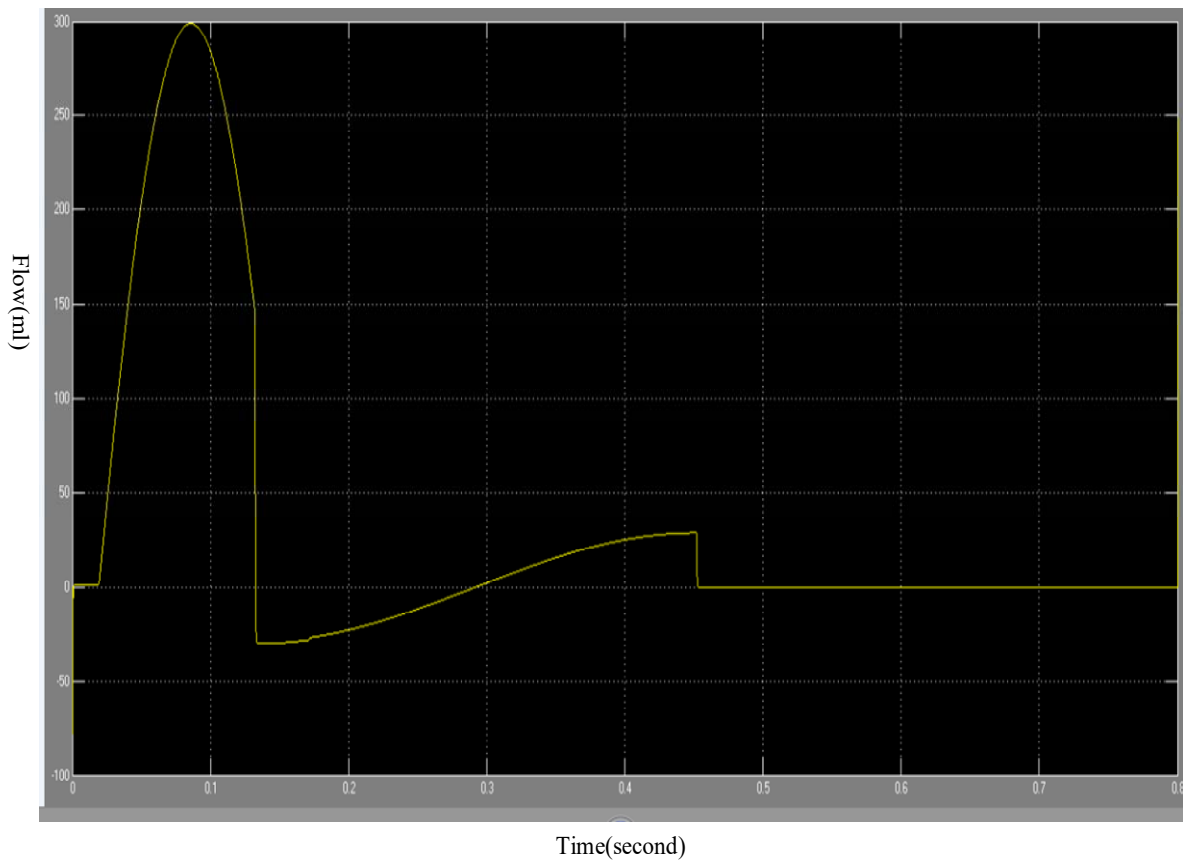

Fig. 14 Flow vs Time Curve for Left Atrium

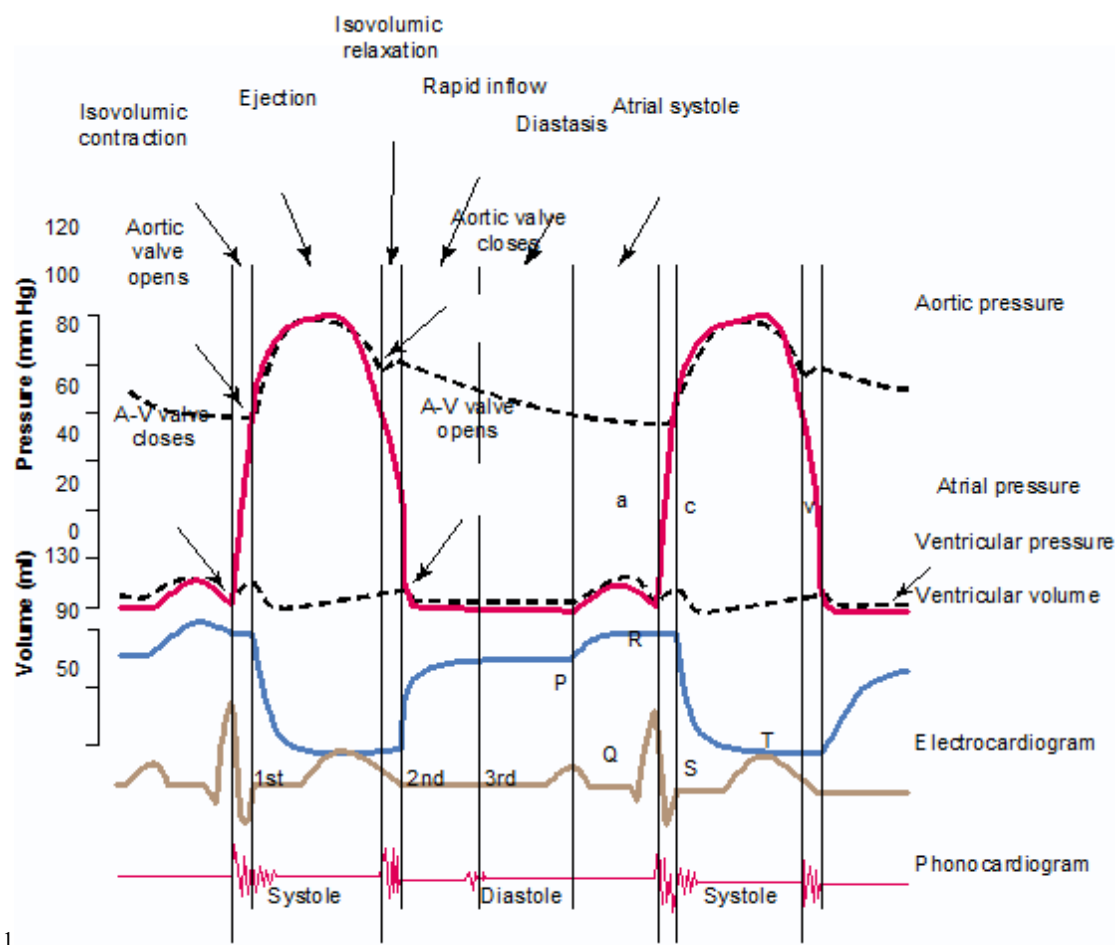

Fig. 15 Events of the cardiac cycle for left ventricular function, showing changes in left atrial pressure, left ventricular pressure, aortic pressure ventricular volume, the electrocardiogram, and the phonocardiogram in [7]

#### REFERENCES

- [1] K. Hassani, M. Navidbakhsh, M. Abdolrazaghi, Mathematical Modelling and Electrical Analog Equivalent of the Human Cardiovascular System, Cardiovascular Engineering, Springer, pp .45-51, 2010.
- [2] A. Avolio, Multi-branched model of the human arterial system, Medical & Biological engineering & Computing, pp. (1980), pp. 709-718, November 1980.
- [3] J. T. Ottesen. M. S. Olufsen, J. K. Larsen, Applied Mathematical Models in Human Physiology, Siam Publication, pp.91-153, 2004.
- [4] K. Hassani, M. Navidbakhsh, M. Rostami, Simulation of the cardiovascular system using equivalent electronics system, J biomedical papers of medical faculty of the university Palacky, Olomouc. 150(1):pp. 105-112, May2006.
- [5] V. C. Rideout, Mathematical and computer modeling of physiological system, New Jersey: Prentice-Hall Inc., pp.27-66,1991
- [6] M. S. Olufsen, A.Nadim, On deriving lumped models for blood flow and pressure in the systemic arteries. J Math Biosci Eng.;1(1):61.,2004
- [7] A. C. Guyton, J. E. Hall, Text book of Medical Physiology, Eleventh edition, Elsevier Saunders, pp. 161-214, 2006.
- [8] J. Keener, J. Sneyd, Mathematical Physiology, Springer- Verlag, New York.Inc. pp. 434-478, 1998.
- [9] L. Formaggia, A. Quarteroni, A. Veneziani, Cardiovascular Mathematics, Modeling and simulation of the circulatory system, Springer- Verlag Italia, Milano 2009.
- [10] Agam Kumar Tyagi, Matlab and Simulink for Engineers, Oxford University Press, pp. 111-158, 2012.
- [11] Boris JA Kogan, Introduction to computational cardiology, Mathematical Modeling and computer simulation, Springer.
- [12] Charles S. Peskin, Numerical Analysis of Blood flow in the Heart, Journal of Computational Physics, 25, 220-252 (1977).
- [13] Mohammad Reza Mirzaee, Omid Ghasemalizadeh, and Bahar Firoozabadi Simulating of Human Cardiovascular System and Blood Vessel Obstruction Using Lumped Method World Academy of Science, Engineering and Technology 41 2008, Page(s) No.267-274.
- [14] Attinger E. O.; Ann; A, A, Simulation of the Cardiovascular System, Annals of the New York Academy of Sciences, 1966, Vol. 128, No. 3, Page(s) 810-829
- [15] Beneken J.E.W.; Rideout V.C. The Use of Multiple Models in Cardiovascular System Studies: Transportation and Perturbation Methods," IEEE Transactions on Biomedical Engineering, October 1968, Vol. BME-15, No. 4, Page(s) 281-289
- [16] Rideout V.C.; and Katra J.A. Computer Study of the Pulmonary Circulation, Simulation, May 1969, Vol. 12, No. 5, Page(s) 239-245
- [17] Snyder M.F.; Rideout V.C. Computer Simulation Studies of the Venous Circulation, IEEE Transactions on Bio-Medical Engineering, October 1969, Vol.BME-16, No. 4, Page(s) 325-334
- [18] Rideout V.C.; Dick D.E. Difference-Differential Equations for Fluid Flow in Distensible Tubes, IEEE Trans Biomed Eng, July 1967, Vol. BME-14, No. 3, Page(s) 171-177
- [19] Rideout, V.C, Cardiovascular System Simulation in Biomedical Engineering Education, Biomedical Engineering, IEEE Transactions on, March 1972, Vol. BME-19, No. 2, Page(s) 101-107 73
- [20] Snyder M.F.; Rideout V.C.; Hillestad R. J. Computer Modeling of the Human Systemic Arterial Tree, Biomech. (Journal of Biomechanics), 1968 ,Vol. 1, Page(s) 341-353.
- [21] John O. Attia, Electronics and Circuit Analysis using Matlab, CRC Press.H. Poor, An Introduction to Signal Detection and Estimation. New York: Springer-Verlag, 1985, ch. 4.

- [22] F. Y. Liang, S. Takagi, R. Himeno, and H. Liu. Biomechanical characterization of ventricular-arterial coupling during aging: A multi-scale model study. *Journal of Biomechanics*, 42:692-704, 2009.
- [23] Nicolaas Westerhof, Nikos Stergiopoulos, Mark I. Noble, *Snapshots of Hemodynamics: An Aid for Clinical Research and Graduate Education*. DOI 10.1007/978-1-4419.6363.5\_38. @ Springer Science + Business Media. LLC 2010.