

Effect of Modeling of Hydraulic Form Loss Coefficient to Break on Emergency Core Coolant Bypass

Young S. Bang, Dong H. Yoon, Seung H. Yoo

Abstract—Emergency Core Coolant Bypass (ECC Bypass) has been regarded as an important phenomenon to peak cladding temperature of large-break loss-of-coolant-accidents (LBLOCA) in nuclear power plants (NPP). A modeling scheme to address the ECC Bypass phenomena and the calculation of LBLOCA using that scheme are discussed in the present paper. A hydraulic form loss coefficient (HFLC) from the reactor vessel downcomer to the broken cold leg is predicted by the computational fluid dynamics (CFD) code with a variation of the void fraction incoming from the downcomer. The maximum, mean, and minimum values of FLC are derived from the CFD results and are incorporated into the LBLOCA calculation using a system thermal-hydraulic code, MARS-KS. As a relevant parameter addressing the ECC Bypass phenomena, the FLC to the break and its range are proposed.

Keywords—CFD analysis, ECC Bypass, hydraulic form loss coefficient, system thermal-hydraulic code.

I. INTRODUCTION

ECC Bypass has been regarded as one of the typical and important phenomena to peak cladding temperature (PCT) in LBLOCA of NPP [1]. Following a LBLOCA, reactor coolant system (RCS) is rapidly depressurized and water from Emergency Core Cooling System (ECCS) is started to inject to the reactor vessel when the RCS pressure decreases to the setting pressure of ECCS actuation. It was known that during the early stage of ECCS injection, substantial amount of the ECCS water may not be introduced to the core by the bypass phenomena to the break due to the interaction with the strong steam-water flow from the reactor vessel to the break. Such a bypass process may be continued even the reflood phase of LBLOCA,

Since the PCT during the reflood phase of LBLOCA may be affected by the extent of ECC Bypass, significant effort has been devoted to quantify the PCT impact of the model both in conservative ECCS evaluation model (EM) and in best estimate (BE) ECCS EM. Especially, BE EM requires uncertainty evaluation for the phenomena including Counter Current Flow Limitation (CCFL) and the hot wall effect in the downcomer [1]. Researches [2] also provided the important findings through the test data and analyses from several integral and

separate effect tests associated to ECC Bypass. Conservative predictions of the ECC Bypass were found based on the available system code calculations. However, which specific model or parameter has an impact on ECC Bypass prediction and how much its uncertainty in the calculation of the LBLOCA is still questionable. One of the reasons may be a difficulty in addressing the ECC Bypass and its impact on PCT in terms of the downcomer parameters such as the CCFL and hot wall effect. Author's recent experience in licensing review of the topical report [3] indicated the hydraulic modeling of break flow has an impact on ECC Bypass, especially in a non-critical break flow regime for the reflood phase. Therefore, HFLC to the non-critical break flow needs to be studied.

The present paper is to discuss a modeling to address the effect of ECC Bypass using the HFLC at the junction from the downcomer to the broken cold leg for the system thermal-hydraulic code, MARS-KS [4]. For this purpose, CFD analysis was conducted to calculate the hydraulic FLC from the reactor vessel downcomer to the break, which is believed to provide the sound basis for the determination of HFLC. The thermal-hydraulic response following the LBLOCA was calculated for several cases including the maximum, mean, and minimum HFLC obtained from the CFD analysis. The HFLC was proposed as a relevant parameter addressing the ECC Bypass phenomena with its uncertainty range.

II. CFD ANALYSIS

The two-phase air-water flow field from the reactor vessel downcomer to the broken cold leg was calculated using a CFD code, ANSYS-CFX 18.1 [5]. The Eulerian-Eulerian type governing equations were solved with the SST turbulence model, which was reported as reasonable for the two-phase flow condition. Computational domain can be shown in Fig. 1, which composed of a part of the reactor vessel downcomer annulus and the broke cold leg. The structured mesh system having about 140,000 hexahedron cells was used.

As a boundary condition at the inlet of the domain, homogeneous flow was assigned with the same velocity (10 m/sec) both for air and for water. The calculation was conducted for the different volume fractions of air from 0 to 1.0.

At the outlet boundary, ambient pressure condition was assigned. The Reynolds number based on properties of air and water and cold leg diameter ranges $2.38 \times 10^6 \sim 4.11 \times 10^7$. Such a condition is believed to be relevant to the actual reflood

Y. S. Bang is with the Korea Institute of Nuclear Safety, Daejeon, Korea (corresponding author, phone 82-42-868-0104; e-mail: k164bys@kins.re.kr).

D. H. Yoon is with the Korea Institute of Nuclear Safety, Daejeon, Korea (phone 82-42-868-0885; e-mail: k976ydh@kins.re.kr).

S. H. Yoo is with the Korea Institute of Nuclear Safety, Daejeon, Korea (phone 82-42-868-0922; e-mail: k720ysh@kins.re.kr).

condition during LBLOCA.

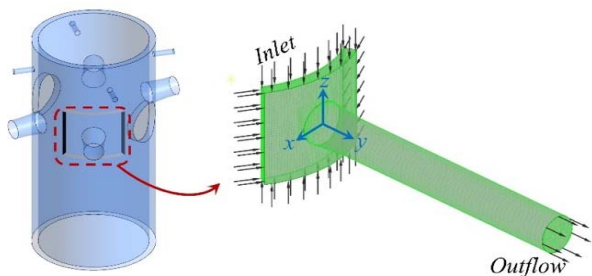
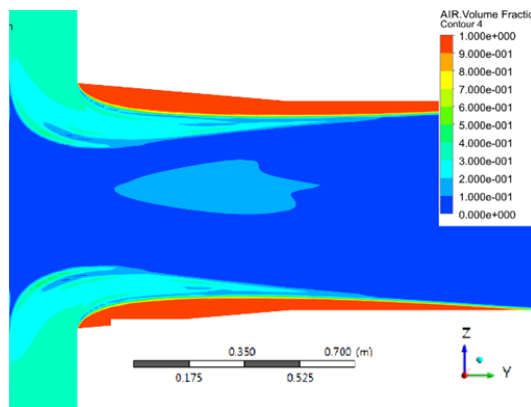

Fig. 1 Computational domain and grid system

Fig. 2 shows the superficial velocity vectors for air and water and water at the y-z plane from the calculation for the case of air volume fraction, 0.3. Also, the contours of the calculated air volume fraction were plotted. In this figure, a separation and recirculation of two-phase air-water flow can be observed at the entrance of the cold leg. It can be found that the region of recirculation was largely occupied by air and was longer than the case of single phase water flow.

Fig. 3 shows the predicted HFLC (K-factor) with respect to the inlet void fraction.



(c)

Fig. 2 Velocity vectors for two-phase flow (air volume fraction=0.3) on the y-z plane; (a) air superficial velocity vectors, (b) water superficial velocity vectors, and (c) air volume fraction

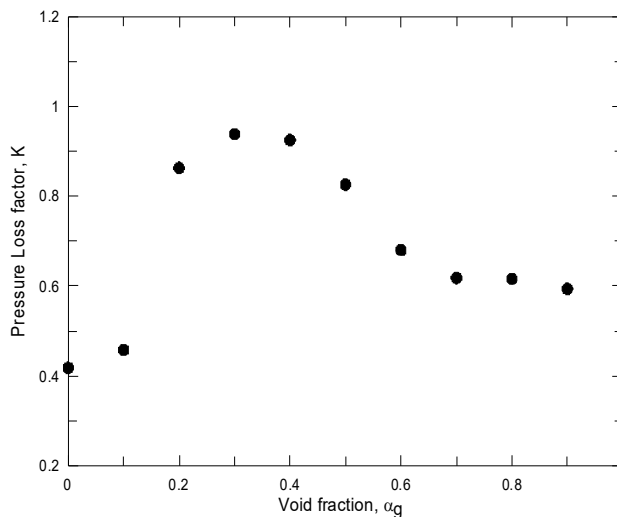

Fig. 3 Predicted HFLC along void fraction

K-factor was calculated by (1) from the CFD calculation results.

$$\Delta p_s + \Delta p_d + \Delta p_g = \frac{1}{2} K (\alpha_g \rho_g U_g^2 + \alpha_f \rho_f U_f^2) \quad (1)$$

Three terms of LHS of (1) are static pressure change, dynamic pressure change, and pressure change by elevation, respectively. RHS of (1) denotes a dynamic pressure considering gas phase and liquid phase. Subscripts g and f mean gas and liquid, respectively. From this figure, one can find that K-factor was almost the same value at the single phase liquid and at the single phase air, which indicated that K-factor in this geometry and flow condition are not dependent on the Reynolds number. However, such a similarity was not valid in two-phase flow regime as shown in Fig. 3. The maximum K-factor was observed at the void fraction 0.3~0.4, which was similar to the previous studies [6]-[8]. Regarding the validation of CFD, further study is needed, however, the predicted HFLC

is believed to be reliable based on the similarity of basic trend to the previous studies. Detailed description of the CFD analysis can be found in [9]. From the CFD analysis, the maximum, mean, and minimum HFLC can be proposed in constant form as:

$$\begin{Bmatrix} k_{max} \\ k_{min} \end{Bmatrix} = k_{mean} + \begin{Bmatrix} 2\sigma \\ -2\sigma \end{Bmatrix} \approx \begin{Bmatrix} 1.0 \\ 0.25 \end{Bmatrix} \quad (2)$$

In (2), k_{max} , k_{min} were determined conservatively by adding the two times of the standard deviation (σ) of the CFD results. It is expected to compensate the uncertainty of CFD analysis.

III. SYSTEM CODE ANALYSIS

Thermal-hydraulic response following a Large Break LOCA was calculated using a system thermal-hydraulic code, MARS-KS 1.4 [4]. MARS (Multi-dimensional Analysis of

Reactor Safety) code has been developed for the realistic multi-dimensional thermal-hydraulic system analysis of light water reactor transients, which was improved and modernized from the RELAP5/MOD3 code [10]. Basic solution schemes of the MARS-KS are identical to the RELAP5/MOD3 code, while the code was reconstructed using the modular structure and a new dynamic memory allocation scheme of FORTRAN90. Also, multi-dimensional hydrodynamic capability was implemented.

A double ended guillotine break at cold leg of Advanced Power Reactors of 1400 MWe (APR1400) in Korea [11] was calculated. APR1400 design has two hot legs and four cold legs. The ECCS has four mechanical trains and each train has a Safety Injection Tank and a Safety Injection Pump. All the ECCS trains were designed to inject to the reactor vessel directly, Direct Vessel Injection (DVI).

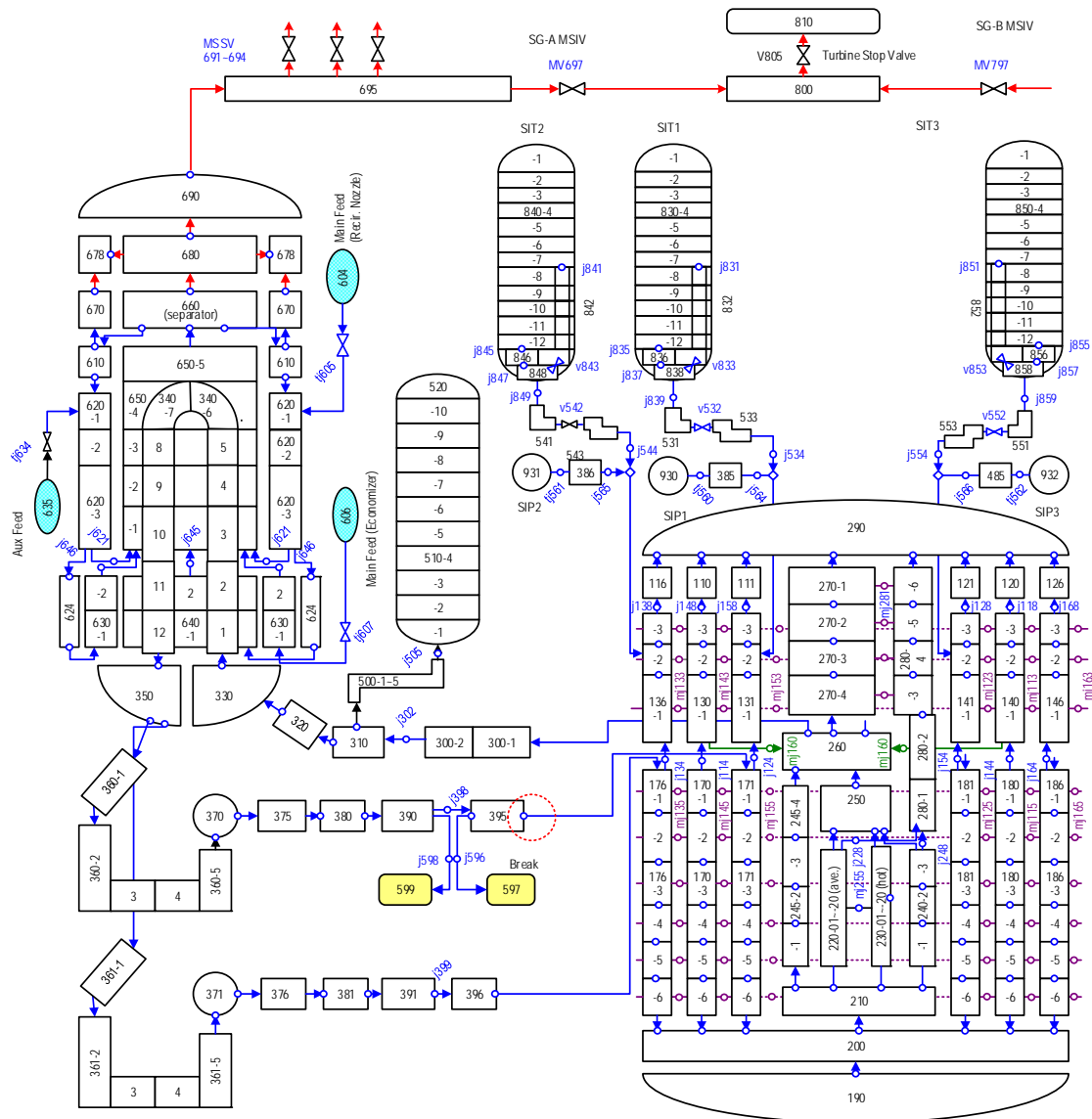

Fig. 4 MARS-KS nodalization for LBLOCA of APR1400

Fig. 4 shows a nodalization for calculating the LBLOCA. The, hot leg, cold legs, Steam Generator, and Reactor Coolant Pumps at the intact side were omitted in Fig. 4. The reactor vessel downcomer, the core, and the upper guide structure were modeled by six circumferential channels with nine axial nodes connected with crossflow junctions, two channels separating a hot fuel assembly and the remaining average fuel assemblies with 20 axial nodes, and two channels with four axial nodes considering the specific geometry, respectively.

For the calculation, the reactor was assumed to operate at the normal 100% power. At the break junction, Henry Fauske critical flow model [12] was applied with the discharge coefficient, $C_D=1.0$ and the non-equilibrium constant of 0.14, and the core decay heat was assumed by ANS73 model. The fuel in reactor core was assumed at a burn-down state of 30,000MWD/MTU (megawatt day per mega tone uranium). Thus, the degraded thermal conductivities of the fuel pellet and the oxidized cladding at the state were applied. By this assumption, additional conservatism corresponding to the worst case of the accident was involved.

The HFLC predicted by the CFD analysis was applied to the junction from the downcomer to the broken loop cold leg. The k-factor discussed above can be effectively incorporated into the calculation, since the MARS code has a flexibility in specifying k-factor by a control component dependent function. Calculations were conducted for the following cases in Table I.

TABLE I
 CASES OF CALCULATION

Case	Description
1	Mean value of K factor of CFD result (k=0.6)
2	Minimum value of K factor of CFD result (k=0.25)
3	Maximum value of K factor of CFD result (k=1.0)
4	k-factor as function of void fraction predicted by CFD

By the case 4, the effect of void fraction dependent HFLC can be found.

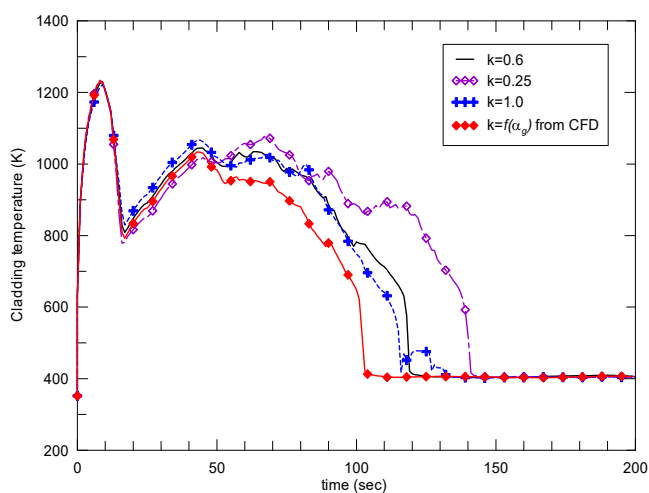

Fig. 5 Comparison cladding temperatures for the different k-factors

Fig. 5 shows a comparison of responses of the maximum cladding temperatures calculated for the cases in Table I. From

this comparison, the PCT in blowdown phase was not so much affected by the k-factor, however, the PCT in reflood phase and the quenching time were sensitively changed by changing the k-factor. The case of minimum k-factor shows a highest reflood PCT and the latest quenching as expected.

The case using the variable k-factor provided from the CFD analysis shows a little lower reflood PCT than the case of k=0.6 and the earlier quenching than the other cases.

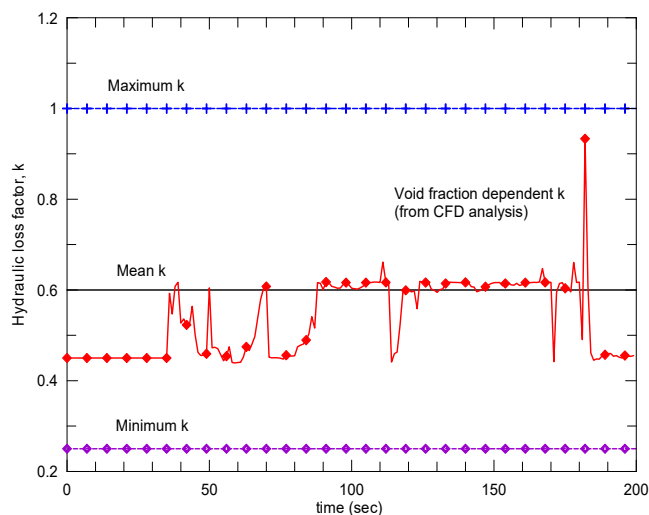

Fig. 6 Comparison of k-factors for the cases calculated

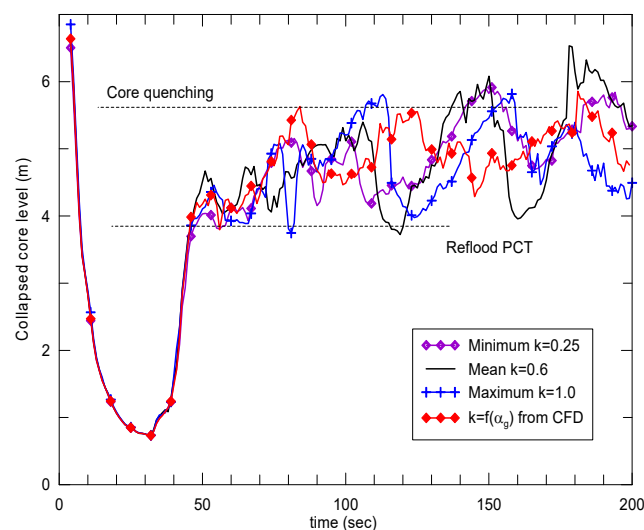

Fig. 7 Comparison of collapsed water level in core

Fig. 6 shows a comparison of the k-factors for each case of calculation. The variable k-factor was shown to be between the minimum k-factor and the mean k-factor, however, the cladding temperature response was beyond the space between those two cases. It means a nonlinearity between the k-factor and the cladding thermal response.

Fig. 7 shows a comparison of the collapsed core water level for the cases calculated. As mentioned above, the almost identical response was found during the critical flow phase (before 45 sec). After that time, k-factor started to impact the

break flow and to change the core level behavior. During the reflood phase, the core level oscillates in a manometric pattern balanced with the downcomer water level. It means that the core water level is changed in opposite direction to the downcomer water level change. However, the core water level is recovered in a short time by the pressure balance between the downcomer and the core. It may cause a difficulty in estimating the trend of PCT and quenching time with variation of k-factor. It can be found that the reflood PCT occurred when the collapsed water level firstly reached 4 m from the bottom of the reactor vessel and final quenching was in place when the core level was firstly recovered to 5.6 m. The timing of PCT and quenching are complex phenomena depending on the k-factor and the resultant oscillation of core water level.

ECCS, a mass flow rate from ECCS, and a mass flow rate discharged to the break among the ECCS injected mass flow rate, respectively. The value of the bypass ratio at the quenching time for each case was described in Table II. As shown in the table, the lower k-factor led to the higher bypass ratio. And the integrated bypass ratio at the final quenching ranges from 0.53 to 0.65, which means only 35~47% of the ECCS water contributes to the core cooling and quenching.

IV. SUMMARY AND CONCLUSIONS

A modeling using a scheme changing the hydraulic resistance at the junction from the reactor vessel downcomer to the broken cold leg to address the effect of ECC Bypass was developed for the system thermal-hydraulic code calculation in the present study. For this purpose, a CFD analysis was conducted to predict the hydraulic resistance with variation of the void fraction incoming from the downcomer. The minimum, the mean, and the maximum hydraulic resistances were derived from the CFD analysis, respectively. Those hydraulic resistances were incorporated into the system thermal-hydraulic code, MARS-KS 1.4, and the thermal-hydraulic response on LBLOCA was calculated for each case. Also, a case implementing the hydraulic resistance with the same function of incoming void fraction as the CFD result was calculated. The following can be concluded.

- 1) The hydraulic resistance at the junction from the downcomer to the broken cold leg can be a relevant parameter for addressing the ECC Bypass phenomena in the system thermal-hydraulic calculation of LBLOCA using MARS-KS code.
- 2) From the CFD calculation of the break flow in a simple geometry, the hydraulic resistance can be obtained with variation of the incoming void fraction.
- 3) Ranges of the hydraulic resistance was proposed as 0.25~1.0 by considering the uncertainty of the CFD calculation as a function of incoming void fraction.
- 4) The effect of the variation of the hydraulic resistance within the proposed range on the reflood PCT was 37K and the effect on the bypass ratio was 0.53 to 0.65 based on the MARS-KS 1.4 code calculation.

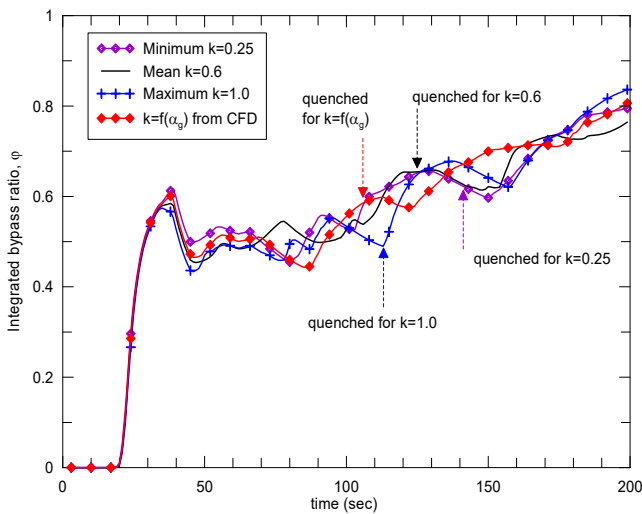

Fig. 8 Comparison of integrated ECC bypass ratio

Fig. 8 shows a comparison of the integrated ECC bypass ratio along the time. The integrated bypass ratio means a total amount of bypassed ECCS water mass until the time t and was calculated by the following equation.

$$\varphi = \frac{\int_{t_{ECCS}}^t \dot{m}_{ECC-Break} dt}{\int_{t_{ECCS}}^t \dot{m}_{ECC} dt} \quad (3)$$

In (3), t_{ECCS} , \dot{m}_{ECC} , $\dot{m}_{ECC-Break}$ denote a starting time of

TABLE II
SUMMARY OF CALCULATION RESULT

Case	Description	Reflood PCT (K)	Time of reflood PCT (sec)	Time of quenching (sec)	Integrated bypass ratio at quenching
1	k=0.6	1039	44	125	0.65
2	k=0.25	1076	67	141	0.625
3	k=1.0	1064	44	115	0.53
4	k=f(α_g) by CFD	1032	43	104	0.57

ACKNOWLEDGMENT

This work was supported by the Nuclear Safety Research Program through the Korea Foundation of Nuclear Safety (KOFONS), granted financial resource from the Nuclear Safety and Security Commission (NSSC), Republic of Korea (No.

1305002).

REFERENCES

- [1] United States Nuclear Regulatory Commission, "Compendium of ECCS Research for Realistic LOCA Analysis," Final Report, NUREG-1230, 1988, pp 6.3-1-33.

- [2] P. S. Damerell, J. W. Simons, "Reactor Safety Issues Resolved by the 2D/3D Program," International Agreement Report, NUREG/IA-0127, 1993, pp 4.1-4.33.
- [3] Korea Hydro and Nuclear Co. and Korea Electric Power Co.-Nuclear Fuel, "LBLOCA Best-Estimate Evaluation Model for APRI400 Type Nuclear Power Plants Using the SPACE Code," Topical Report TR-KHNP-0030, August 2017, pp. 6-7.
- [4] Korea Institute of Nuclear Safety, "MARS Code Manual - Volume II: Input Requirements," KINS/RR-1282, Rev.2, May 2016.
- [5] Ansys Inc., ANSYS CFX-18, 2017.
- [6] Wadle, M. A., "A new formula for the pressure recovery in an abrupt diffuser," *International Journal of Multiphase Flow*, Vol. 15, No. 2, 1989, pp. 241~256.
- [7] Schmidt, J. and Friedel, L., "Two-phase pressure drop across sudden contractions in duct areas," *International Journal of Multiphase Flow*, Vol. 23, No. 2, 1997, pp. 283~299.
- [8] Roul, M. K. and Dash, S. K., "Two-phase pressure drop caused by sudden flow area contraction/expansion in small circular pipes," *Int. J. Numer. Mech. Fluids*, Vol. 66, 2011, pp. 1420~1446
- [9] D. H. Yoon, Y. S. Bang, "CFD Analysis for Two-phase Flow Pressure Drop through Broken Cold Leg in Reactor Downcomer," *Trans. KSME 2017 Autumn Meeting*, 2017, pp. 2501-2505.
- [10] Information Systems Laboratories, Inc. RELAP5/MOD3.3 Code Manual Volume I: Code Structure, System Models, and Solution Methods, NUREG/CR-5535/Rev P5-Vol I, 2016.
- [11] Korea Hydro and Nuclear Co. "Shinkori Units 3 and 4, Final Safety Analysis Report," 2015, pp. 6.3-1~89.
- [12] R. E. Henry and H. K. Fauske. "The Two-Phase Critical Flow of One-Component Mixtures in Nozzles, Orifices, and Short Tubes." *Transactions of ASME, Journal of Heat Transfer*. 93. 1971, pp. 179-187.