

An Analysis of the Optimization Condition of Plasma Generator for Air Conditioner System

Arunrungrusmi S, Chaokammerd W , Tanitteerapan T , Mungkung N., and Yuji T.

Abstract—This research aimed to develop plasma system used in air conditioners. This developed plasma system could be installed in the air conditioners - all split type. The quality of air could be improved to be equal to present plasma system. Development processes were as follows: 1) to study the plasma system used in the air conditioners, 2) to design a plasma generator, 3) to develop the plasma generator, and 4) to test its performance in many types of the air conditioners. This plasma system was developed by AC high voltage – 14 kv with a frequency of 50 kHz. Carbon was a conductor to generate arc in air purifier system. The research was tested by installing the plasma generator in the air conditioners - wall type. Whereas, there were 3 types of installations: air flow out, air flow in, and room center. The result of the plasma generator installed in the air conditioners, split type, revealed that the air flow out installation provided the highest average of o-zone at 223 mg/h. This type of installation provided the highest efficiency of air quality improvement. Moreover, the air flow in installation and the room center installation provided the average of the o-zone at 163 mg/h and 64 mg/h, respectively.

Keywords—Air Conditioner, Plasma generator, High voltage, Optimization, Installation position.

I. INTRODUCTION

THE whole world is facing the greenhouse effect along with air pollution. Air conditioning, in other words cooling down the temperature, is not enough when compared to the

demand of the humanity nowadays, especially when health is the main factor considered. Air purification is another issue in which people are getting more and more interested. Every air conditioner sold today, therefore, is equipped with air purification system as an optional feature for customers [1]-[3]. Air purification systems nowadays are classified according to the source as follows: Heppa air purifier, carbon, ozone, water, and plasma. Plasma system is the most widely used at present. However, plasma system has some limits affecting its efficiency and the satisfaction of both customers and manufacturers, which are as follows: it can be installed in only one type of air conditioner, namely wall type; plasma generator is too large; customers who have installed air conditioner must re-install it; it is overpriced; it reduces the efficiency of cooling down the temperature; it makes noise when arc is generated; the amount of plasma could not be controlled; and it smells bad after turning on for a long period. According to the limitations cited above, this research was aimed to develop a prototype of plasma generator with the following features: it could be installed in all split type air conditioners; it is small enough; it could be easily installed; customers who have installed air conditioner could install it without buying new air conditioner; the price is reasonable; it does not reduce the efficiency of cooling down the temperature; and it does not make noise when arc is generated.

II. EXPERIMENTAL SYSTEM DESIGN

According to the fact that the researchers have installed air conditioners, it was found that modern air conditioners are equipped with more features, especially features concerning the efficiency in controlling and cleansing the air by installing plasma generator at the place called “air flow in” of wall type air conditioner. This type of air conditioner is very popular due to the fact that it is small when compared to other types of air conditioners and that it operates almost in silence along with its attractive design. After air conditioner with plasma generator was installed, it was found that the air inside the room was purer and people could breathe smoothly without bad smell. However, the drawback was that plasma generator depends on the decomposition of hydrogen and oxygen. In order to utilize the decomposition and the composition of those gases to make plasma work the most efficiently, it takes a long time. A good installation should be at the place where air flows out since the air flowing out, when the compressor is turned on, is extremely cold, or 2-12° Celsius. Nowadays plasma generator is too large to be installed at air-flow-out area; the efficiency is reduced, thus.

Manuscript received June 2, 2007. This work was supported by Electrical Technology Education Department, Faculty of Industrial Education and Technology, King Mongkut's University of Technology Thonburi, Bangkok, Thailand.

Somchai Arunrungrusmi is with the Electrical Technology Education Department, King Mongkut's University of Technology Thonburi, Bangkok, Thailand (e-mail: somchai.aru@kmutt.ac.th).

Weerachai Chaokammerd is with telecommunication management , Dhurakij Pundit University, Bangkok, Thailand.

Tanes Tanitteerapan is with the Electrical Technology Education Department, King Mongkut's University of Technology Thonburi, Bangkok, Thailand (e-mail: narong_kmutt@yahoo.com).

Narong Mungkung is with the Electrical Technology Education Department, King Mongkut's University of Technology Thonburi, Bangkok, Thailand (e-mail: somchai.aru@kmutt.ac.th).

Toshifumi Yuji is currently a Lecturer in Faculty of Education and Culture, University of Miyazaki, Miyazaki, Japan. His research interests are plasma application and electric power installation. He is a member of the Institute of Electrical Engineers of Japan and the Japan Society of Applied Physics.

III. EXPERIMENTAL EQUIPMENTS

In order to build up air purification system and to collect data for the development of plasma generator, the following tools and equipment are needed for the research: a new wall type air conditioner with 36400 watts to be installed in a room of 16 square meters, digital temperature measuring tool, high-voltage electrical power measuring tool, plasma generator measuring tool, tool to measure wind speed level of sending and returning point of air conditioner, and tool to measure the volume of ozone in the test room [5-6].

IV. HIGH VOLTAGE CIRCUIT FOR PLASMA SOURCE

According to Fig. 1, high voltage circuit for plasma source is shown. This is to build up plasma air purifier system in which the voltage at output is measured to be around 14 kv and follows the arc generation process as shown in Fig. 2. Fig. 3 shows the arc in high voltage probe of plasma generator.

plasma generator would be surrounded by water molecules in the room. Infective particles in the air, comprising hydrogen, would be destroyed by the negative electric charge from the plasma generator at last.

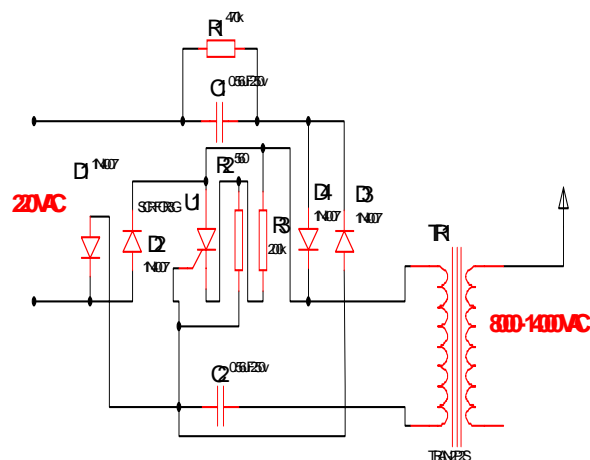

Fig. 1 High Voltage Circuit for Plasma Source

V. EXPERIMENTAL TEST PROCEDURE

In order to experiment air conditioner, the plasma generator would be installed in a split type air conditioner with 2000 watts. There were 3 types of installation:

1. Air flow in

The installation was done at the position, inside air conditioner, where air flows in. This means the plasma generator was installed at the place before the air is cooled down.

2. Air flow out

The installation was done at the position, inside air conditioner, where air flows out. This means the plasma generator was installed at the place after the air is cooled down.

3. Room center

The installation was done in the center of the room. The measurement of ozone quantity was done after the air conditioner had operated for an hour.

VI. RESULTS AND DISCUSSION

Figs. 4 to 8 show the results which revealed the relationship between ozone quantity and speed level according to plasma generator positions and temperatures. According to Fig. 4 to 8, it was found that the installation of plasma generator at the position where air flows out provided the highest average of ozone quantity, when compared to air flow in and room center installations, at 24 to 26 degree. Moreover, it was found that the higher the speed level, the more the ozone quantity and there was the highest average of ozone quantity according to air flow out installation. The room center installation provided the lowest average of ozone quantity. The temperature and the speed level did not affect the ozone quantity in the room at all. The reason why the ozone quantity in the room with the air flow out installation was higher than air flow in and room center installations was because there was more humidity. When plasma generator operated, there was negative electric charge and at the same time the air around the cold coil was extremely humid, splitting water molecules in the air [4]. After the water molecules split, the negative electric charge from the

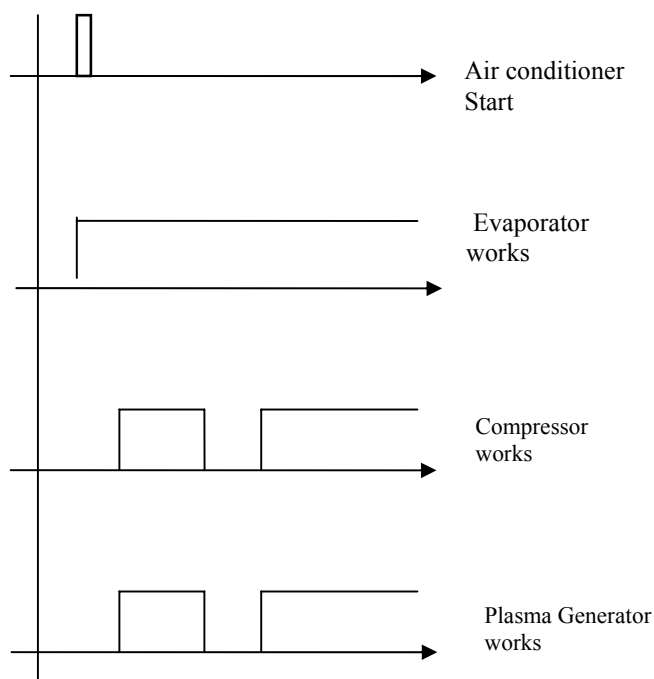

Fig. 2 Arc Timing Diagram

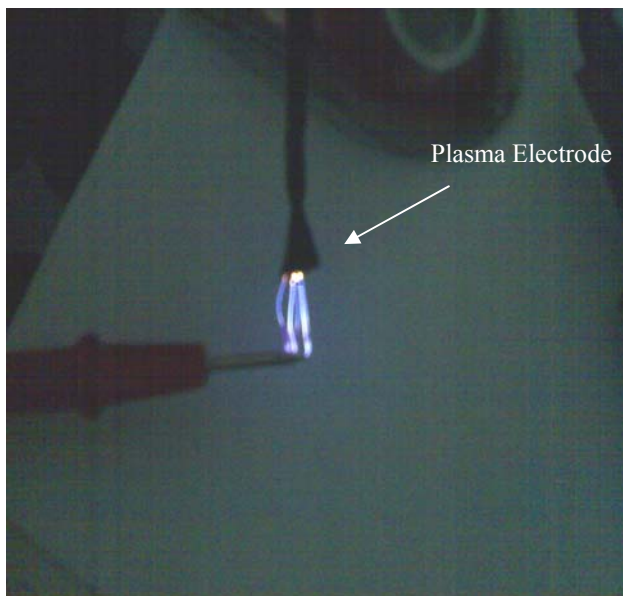

Fig. 3 Typical Plasma Arc in High voltage Electrode

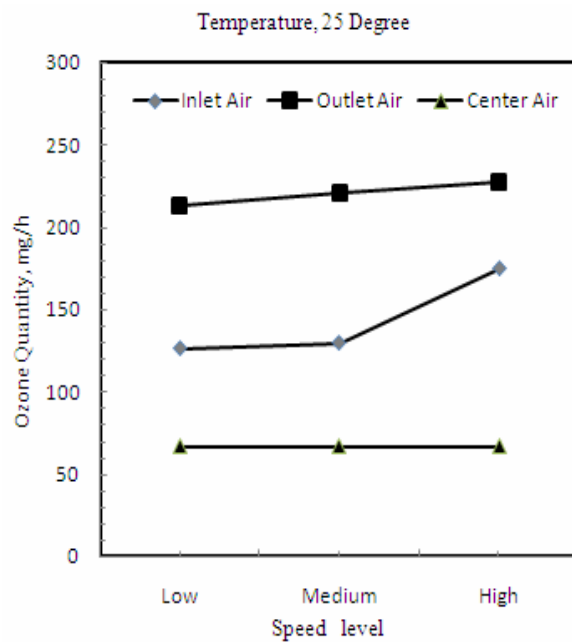

Fig. 5 Ozone Quantity vs Plasma Generator Position and Speed Level (25 Degree)

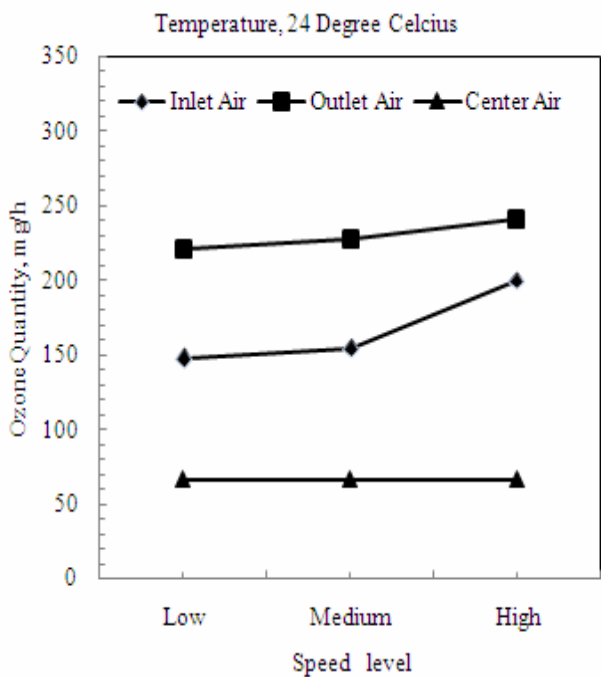

Fig. 4 Ozone Quantity vs Plasma Generator Position and Speed Level (24 Degree)

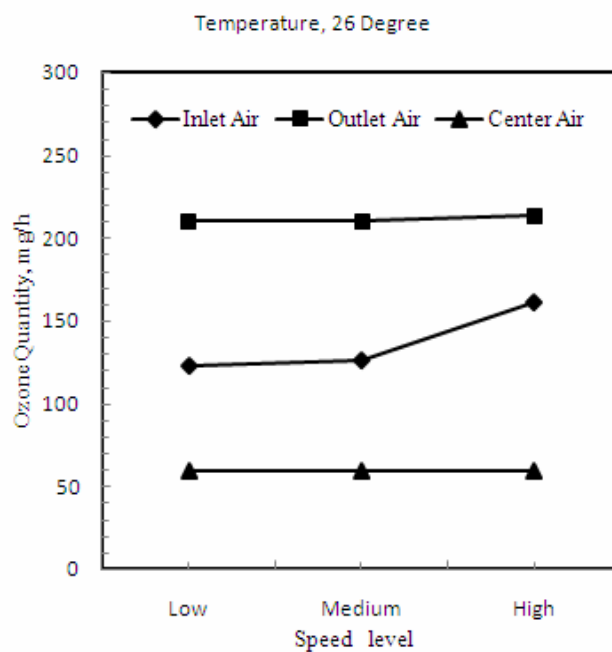

Fig. 6 Ozone Quantity vs Plasma Generator Position and Speed Level (26 Degree)

Open Science Index, Electrical and Computer Engineering Vol:3, No:5, 2009 waset.org/Publication/8181

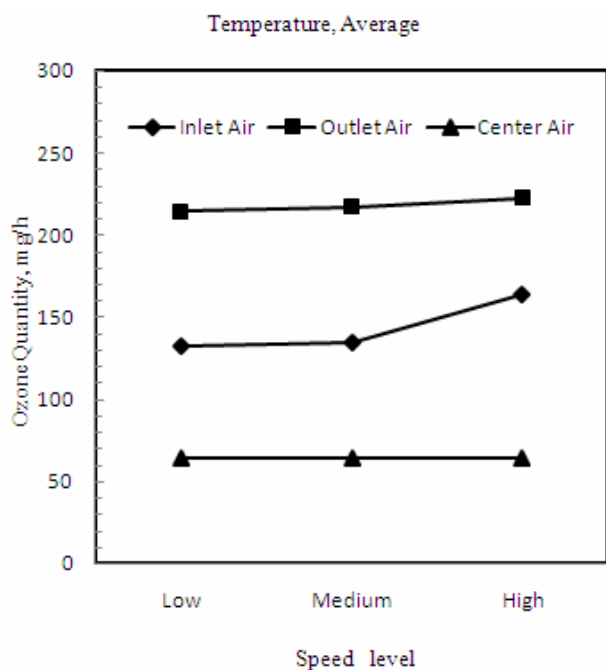

Fig. 7 Ozone Quantity vs Plasma Generator Position and Speed Level (Average Degree)

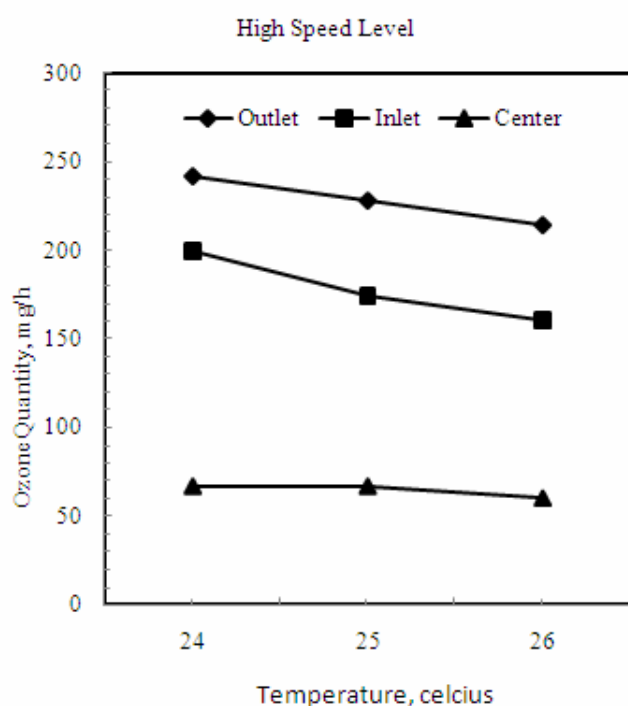

Fig. 8 Ozone Quantity vs Temperature set up (High Speed)

VII. CONCLUSION AND SUGGESTIONS

This research was aimed to develop plasma system used in air conditioners without plasma system. This developed plasma system could be installed in all split type air conditioners. It also improves the air quality as efficiently as the plasma system available at the present time. Development processes were as follows: to study the plasma system used in the air conditioners,

to design a plasma generator, to develop the plasma generator, and to test its performance in many types of the air conditioners. This plasma system was developed by AC high voltage – 14 kv with a frequency of 50Hz. Carbon was a conductor to generate arc in air purifier system [4][7]. The research was conducted by installing the plasma generator in wall mounted type air conditioners with 3 types of installation: air flow out, air flow in, and room center. The result shows that the plasma generator installed in split type air conditioners could purify the air as efficiently as the plasma system available at the present time. The result of experiment with the efficiency of installations reveals that the air flow out installation worked the most efficiently at 24 degree and the installation had to be done at the position where air flows out in front of cold coil of the air conditioner. The air flow out installation provided the highest average of ozone quantity at 223 mg/h. This type of installation provided the highest efficiency of air quality improvement. The air flow in installation and the room center installation provided the average of the o-zone at 163 mg/h and 64 mg/h, respectively. Due to the fact that this research was the first step, it needed more statistical data. Further research works should be to design a larger circuit in order to generate arc for larger room, to experiment with various types of air conditioners installed in the same room in order to achieve the accuracy, and to develop automatic control system.

REFERENCES

- [1] Horvath, M., L. Bilitzky and J. Huttner, 1985, co-ed., Ozone, Adademiai Kiado, Budapest.
- [2] Kondratyev, K.I.A., 2002, Global Environment Change : modeling and monitoring, Springer, Germany.
- [3] Langlais, B., D.A. Reckhow and D.R. Brink, 1991, Ozone in Water Treatment, Lewis Publisher, Michigan, U.S.A.
- [4] Halliday, D., R. Resnick and J. Walker, 2001, Fundamental of Physics Sixth Edition, John Wiley Sons, New York, U.S.A.
- [5] D.S.L. Simonetti, J. Sebastian, F.S. dos Reis and J. Uceda, 1992, "Design Criteria for Sepic and Cuk Converters as Power Factor Oreregulators in Discontinuous Conduction Mode", IEEE Transactions on Industrial Power Electronics, 0-7803-0582- 5/92, pp.283-288.
- [6] R.W. Erickson and D. Maksimovic, 1997, Fundamentals of Power Electronics, 2nd ed, Chamman & hall, pp. 22-124.
- [7] Dordrecht et.al, 1999, The modern problems of electrostatics with applications in environment protection, Kluwer Academic Publilisers.

Somchai Arunrungrasmi was born in Chonburi Province, Thailand, in 1972. He received the B.S.Ind.Ed. degree in electrical engineering from King Mongkut's University of Technology, Thonburi, Thailand, in 1995, the M.S. degree in electrical engineering from King Mongkut's University of Technology Thonburi, Thailand, in 2000. Currently he is a lecturer of Department Electrical Technology Education, Faculty of Industrial Education and technology, King Mongkut's University of Technology Thonburi, Thailand. His main research interests are in engineering education, image processing, geographic information system, energy, material sciences and system design.

Weerachai Chaokummerd is telecommunication management director, Dhurakij Pundit University, Bangkok, Thailand. His main research interests are telecommunication management, control system, electrical and electronic system.

Narong Mungkung was born in Lopburi Province, Thailand, in 1965. He received the B.S.Ind.Ed. degree in electrical engineering from King Mongkut's University of Technology, Thonburi, Thailand, in 1992, the M.S.Tech.Ed degree in electrical technology from King's Institute of Technology, North Bangkok, Thailand, in 1998, the M.S. degree and D.Eng in electrical engineering from Nippon Institute of Technology, Saitama, Japan, in 2000 and 2003. Currently he is Assoc Prof. of Department Electrical Technology Education, Faculty of Industrial Education and technology, King Mongkut's University of Technology Thonburi, Thailand. His main research interests are in engineering education, electrical discharge, plasma application, energy conversion system and high voltage.

Tanes Tanitteerapan was born in Yala, Thailand, in 1971. He received the B.S.Ind Ed. in electrical engineering in 1994 from King Mongkut's University of Technology Thonburi, Bangkok, Thailand, the M.S degree in High Voltage Measuring System from Department of Electrical and Electronics Engineering, Nippon Institute of Technology, Saitama, Japan in 2000 and the Doctor of Engineering in Power Electronics Engineering at Mori Shinsaku Laboratory, Nippon Institute of Technology, Japan in 2003. Currently he is Assistant Professor of Department Electrical Technology Education, Faculty of Industrial Education, King Mongkut's University of Technology Thonburi, Thailand. His research interests include soft-switching power factor correction converters, simple wave shaping techniques for high power factor rectifiers in CCM operation, single-stage power factor correction converters, Photovoltaic Powered Applications, Electrical Teaching Methods.

Toshifumi Yuji was born in Miyazaki, Japan, on June 2, 1976. He received the M.E. degree from the University of Miyazaki, Miyazaki, Japan, in 2003 and the Ph.D. degree from the Tokyo Institute of Technology, Tokyo, Japan, in 2007. He became a Research Associate at Hiroshima National College of Maritime Technology in 2005 and Assistant Professor at Oita National College of Technology in 2006. He is currently a Lecturer in Faculty of Education and Culture, University of Miyazaki, Miyazaki, Japan. His research interests are plasma application and electric power installation. He is a member of the Institute of Electrical Engineers of Japan and the Japan Society of Applied Physics.